

Aim: 88 970 117 alarm message on your mobile phone.
Objectif : réception sur votre téléphone mobile d'un message d'alarme provenant du 88 970 117.
Zweck: Empfang einer Alarmmeldung vom 88 970 117 an Ihrem Mobiltelefon.
Objetivo: Recepción, en el teléfono móvil, de un mensaje de alarma procedente del 88 970 117.
Obiettivo: Ricezione sul cellulare di un messaggio d'allarme proveniente dalla 88 970 117.

A Required hardware / Matériel nécessaire / Erforderliche Hardware
Material requerido / Hardware richiesto

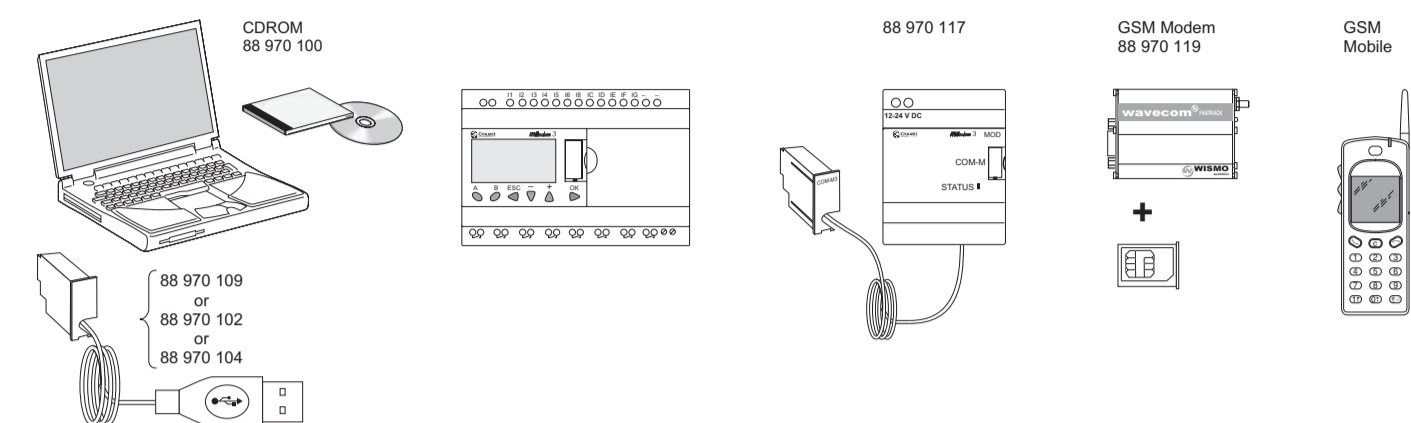

B Hardware cabling for programming and transfer / Câblage du matériel pour la programmation et le transfert / Verkabelung der Hardware für die Programmierung und die Übertragung
Cableado del material para la programación y la transferencia / Cavi di collegamento per la programmazione e il trasferimento.

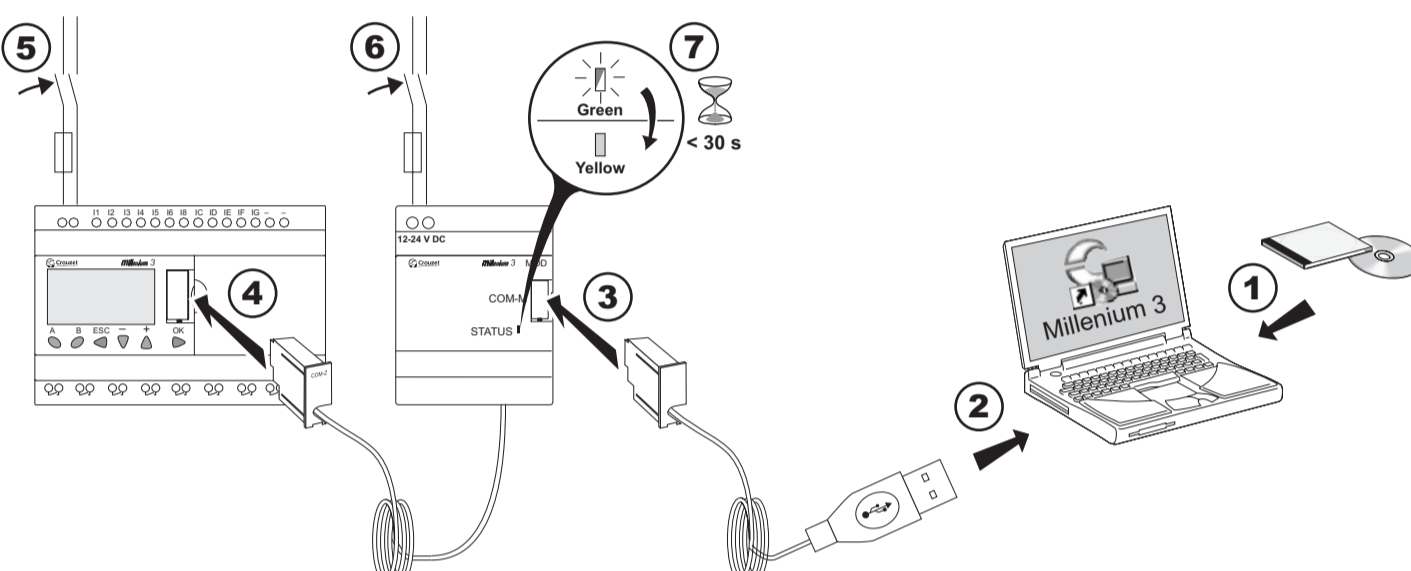

HVS PRECONSTATORE DE SOLUTIONS DEPUIS 1988
 2 rue René Laennec 51500 Taissy France Fax: 03 26 85 19 08, Tel : 03 26 82 49 29
Crouzet NTR 788 A 07 - 2006
 E-mail: hvssystem@hvssystem.com Site web : www.hvssystem.com

D

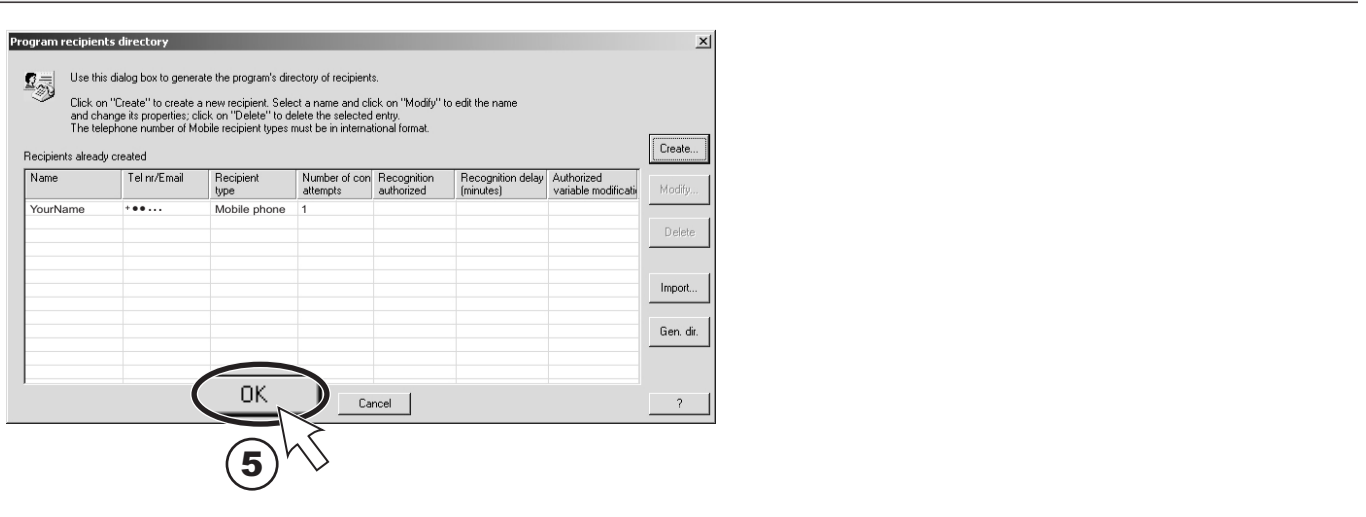
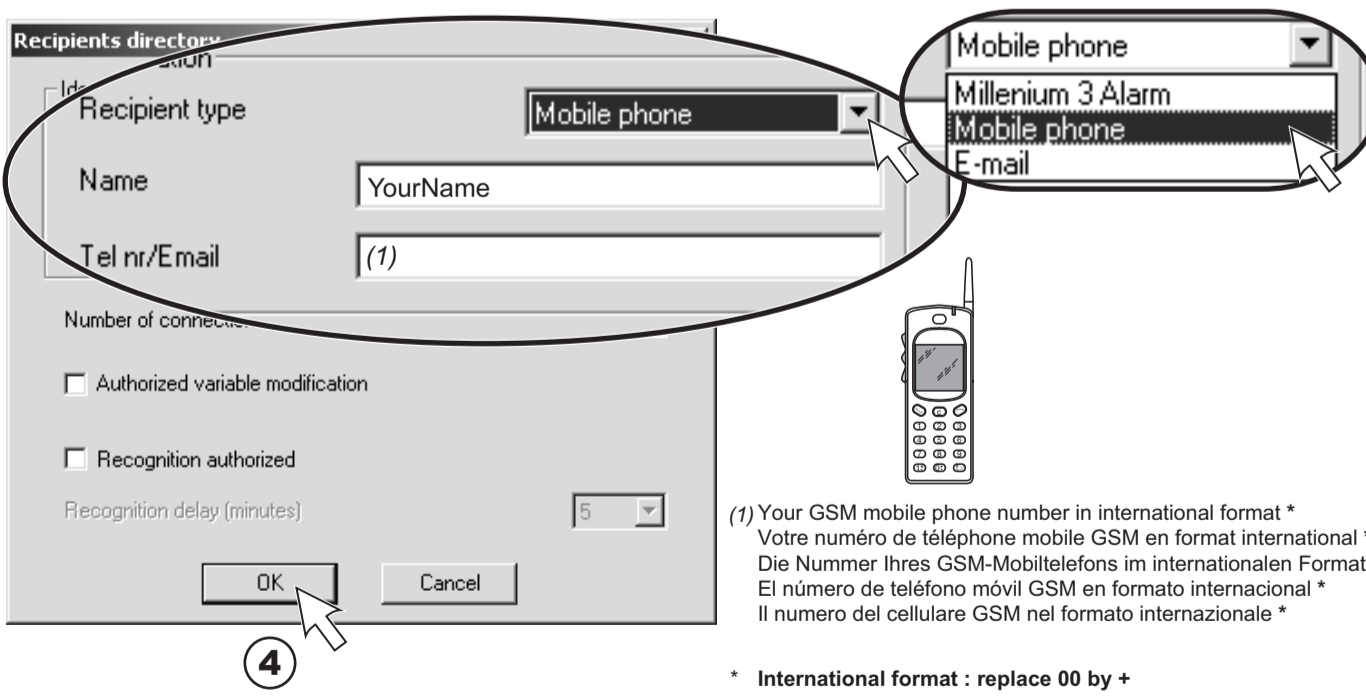
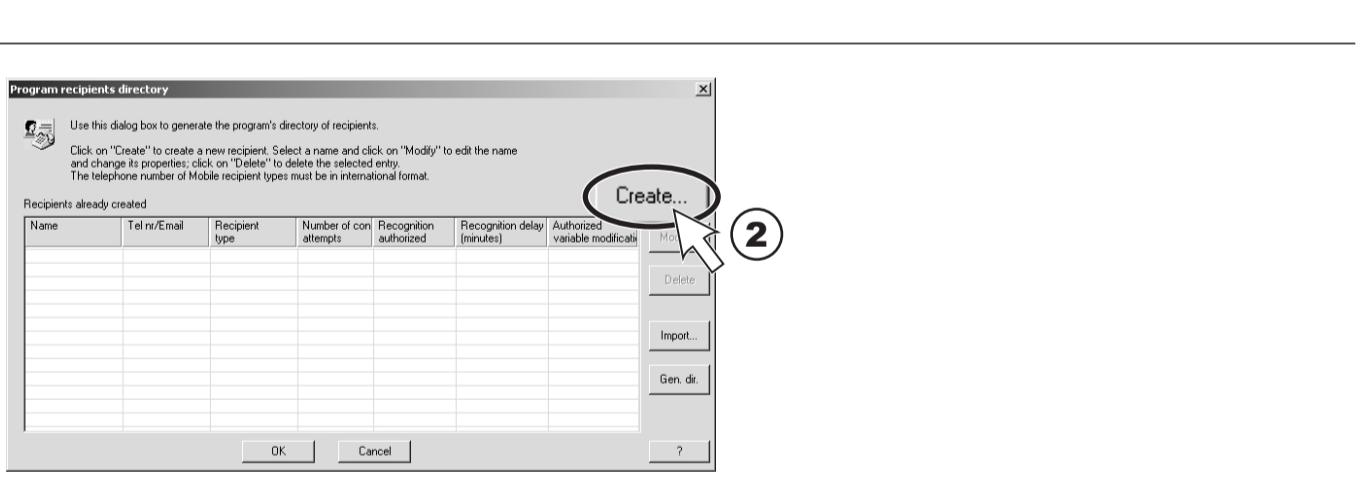

Programming and transfer / Programmation et transfert / Programmierung und Übertragung
Programación y transferencia / Programmazione e trasferimento

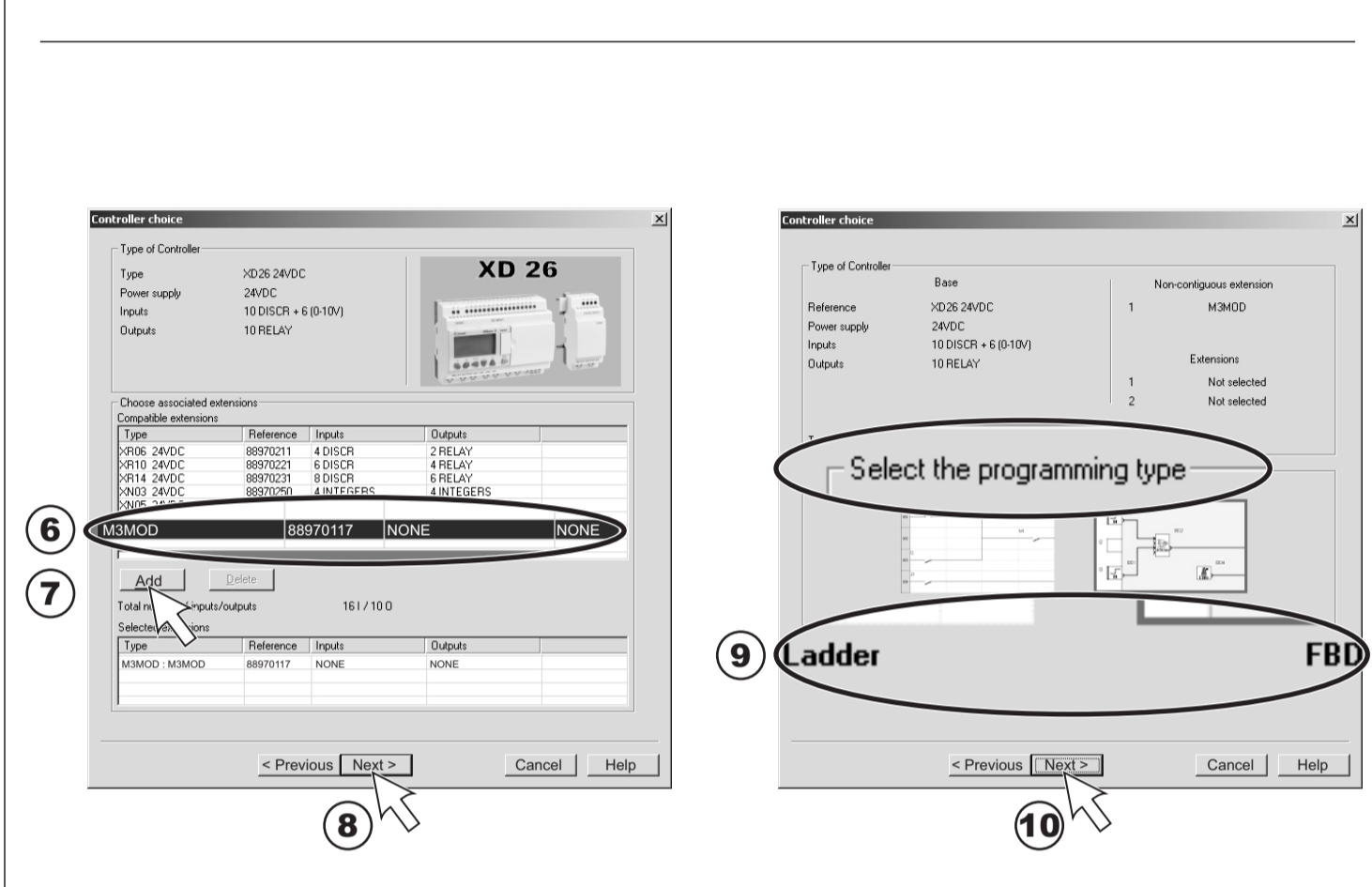
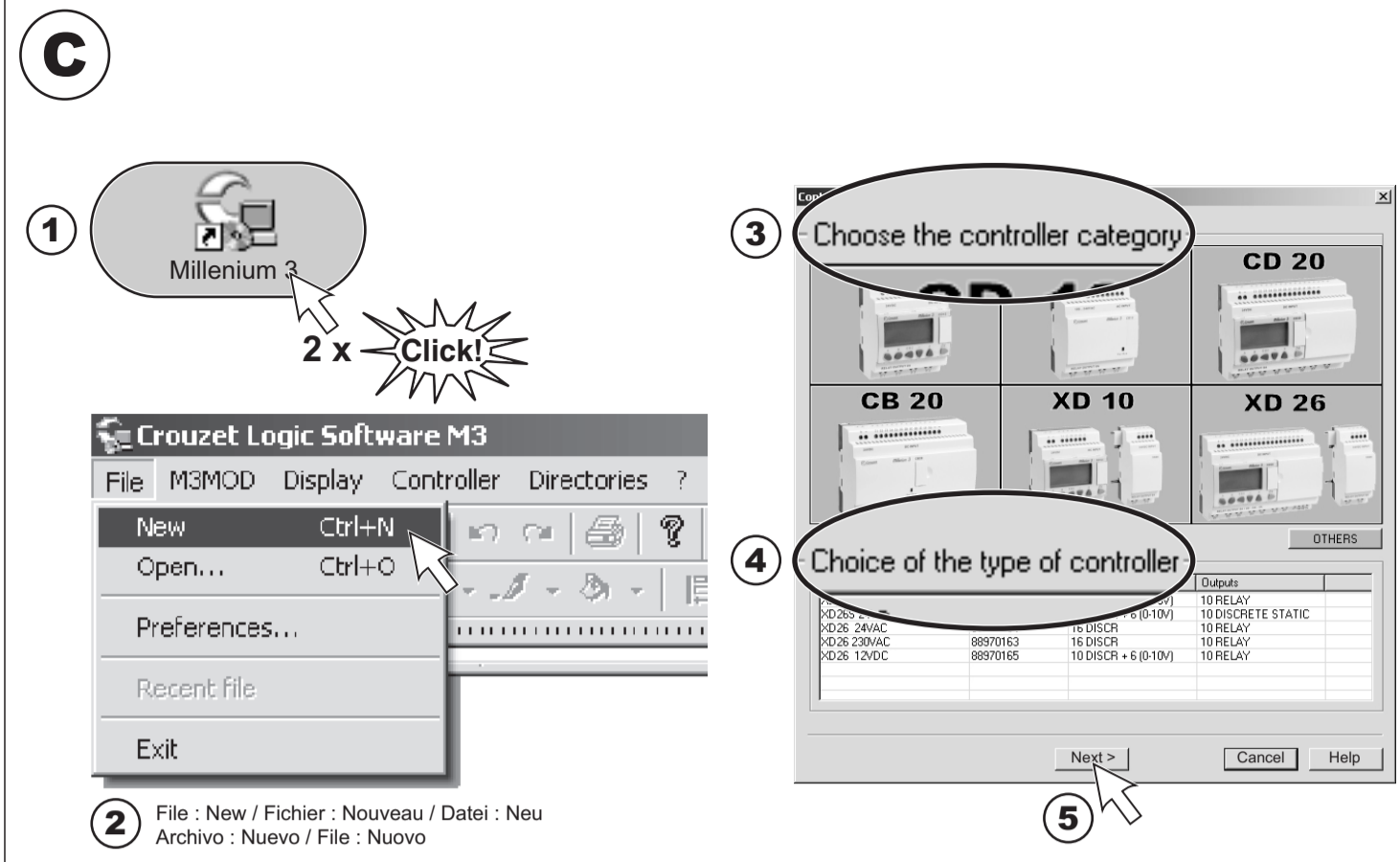

E

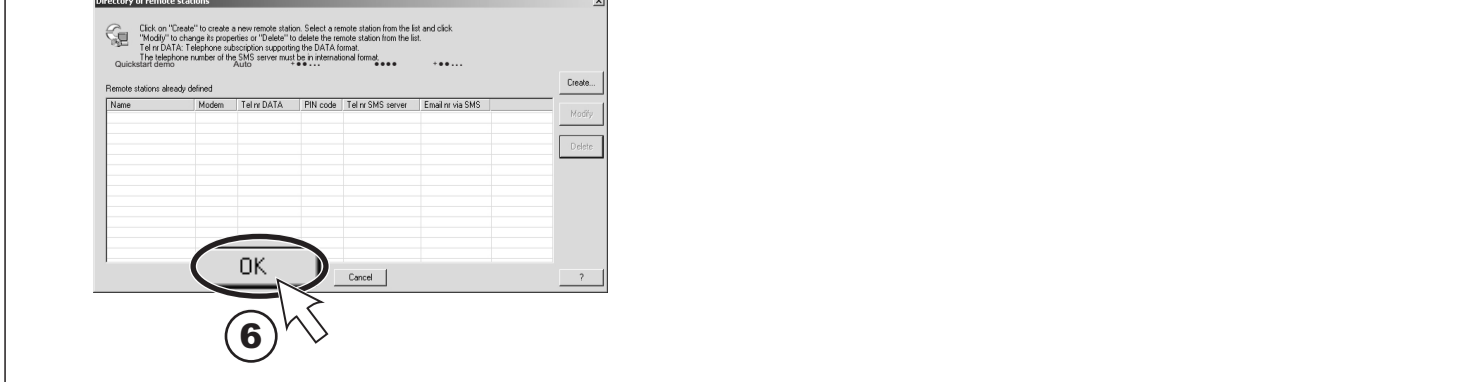
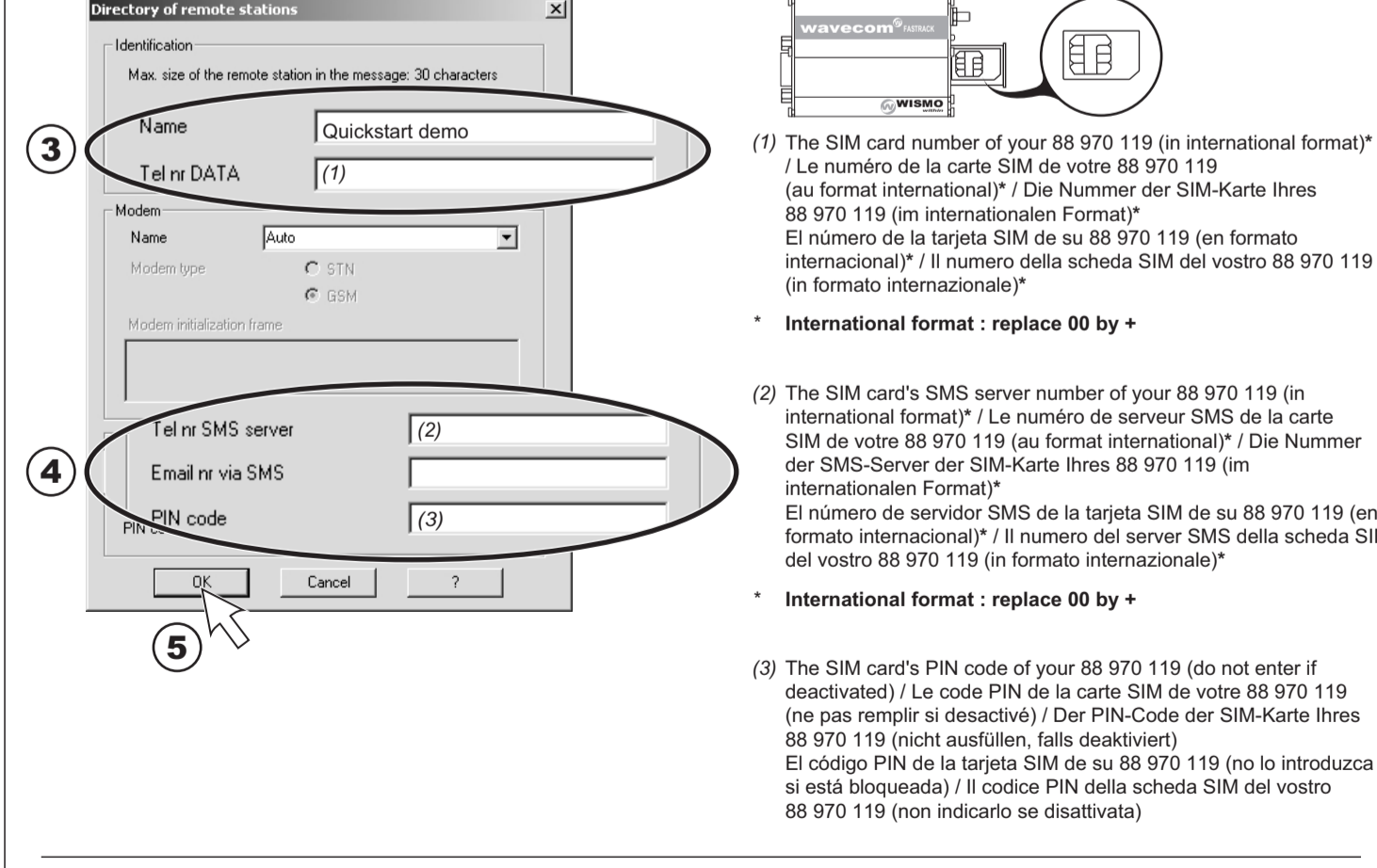
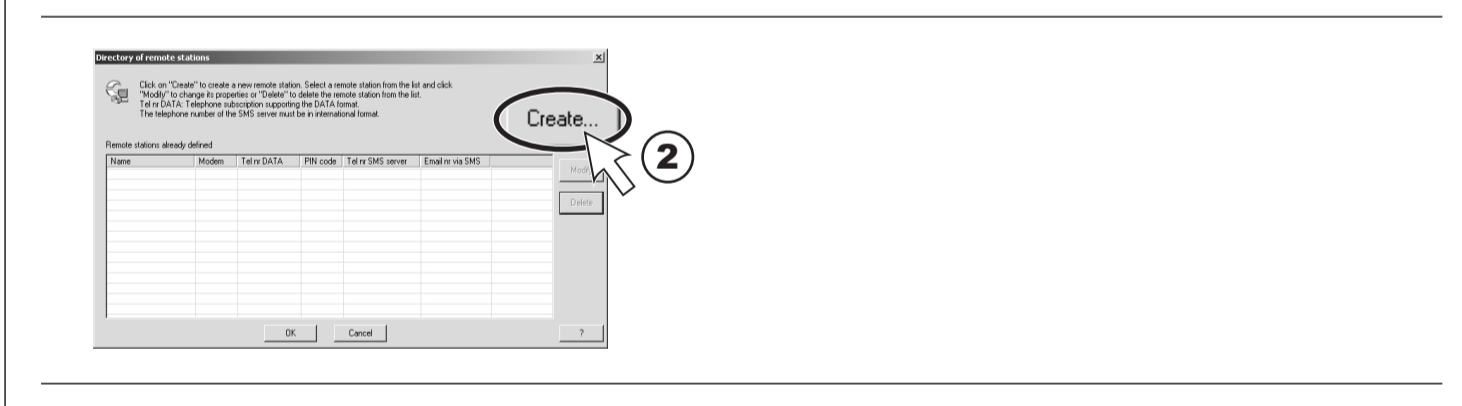

F FBD

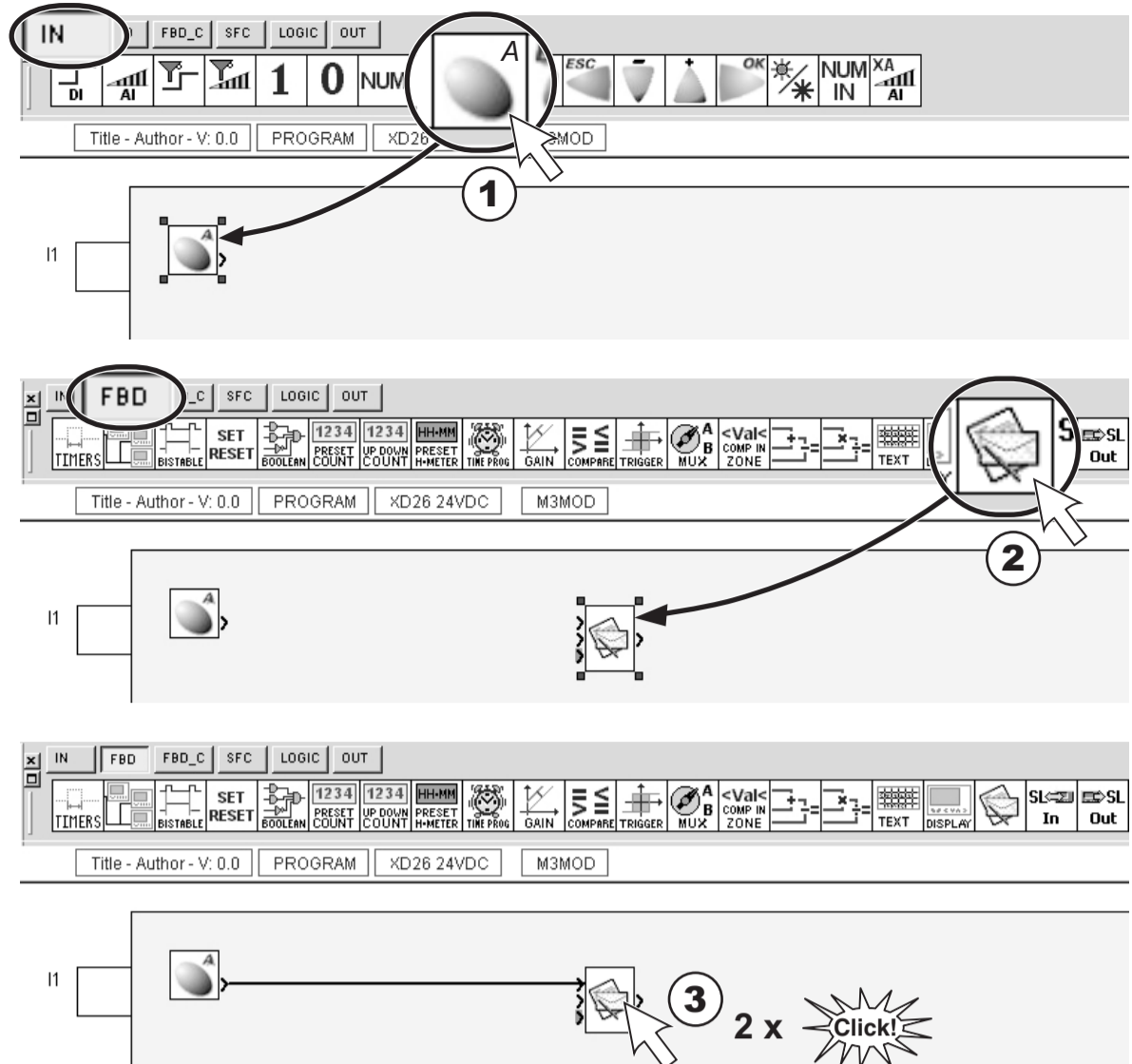

or / ou / oder / o bien / oppure

Ladder

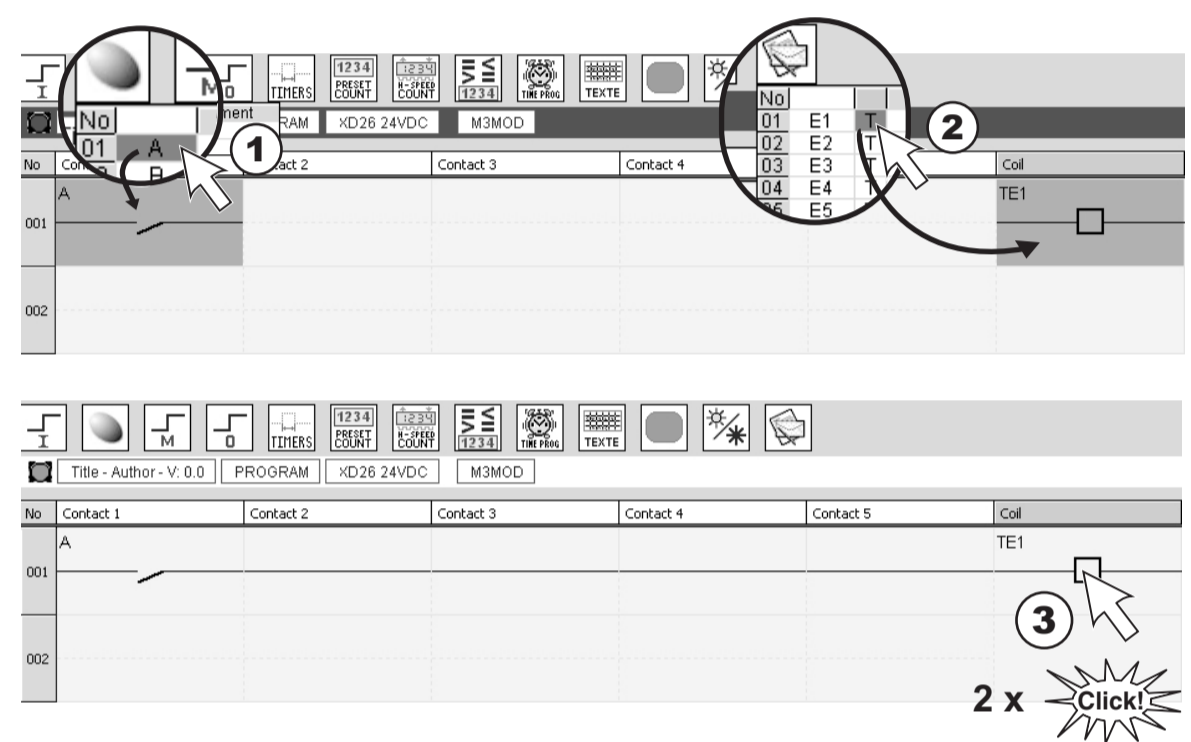

5/8

G

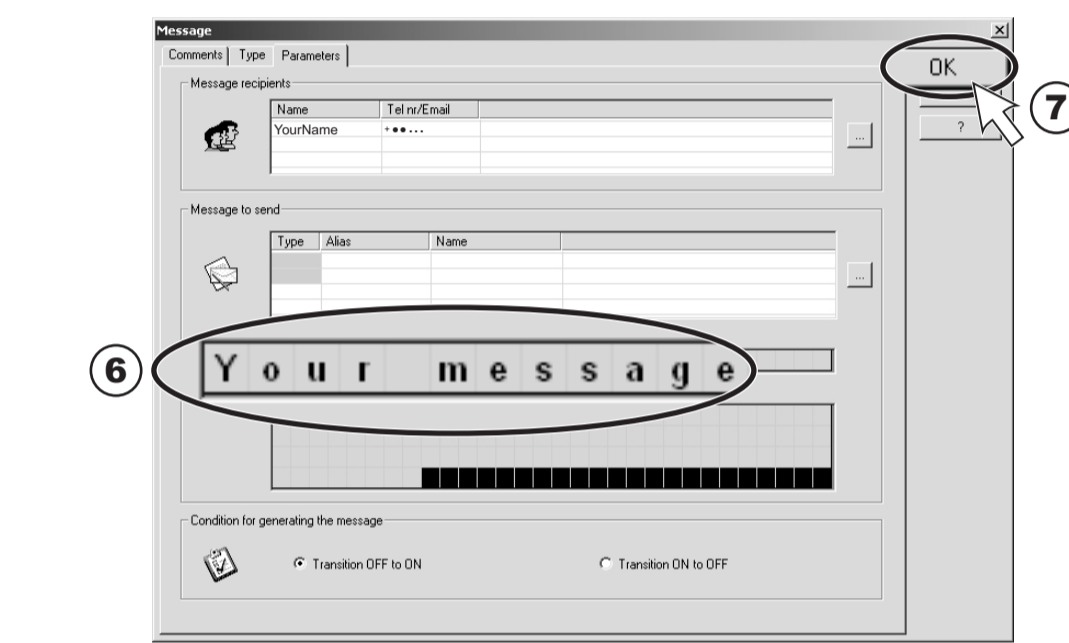
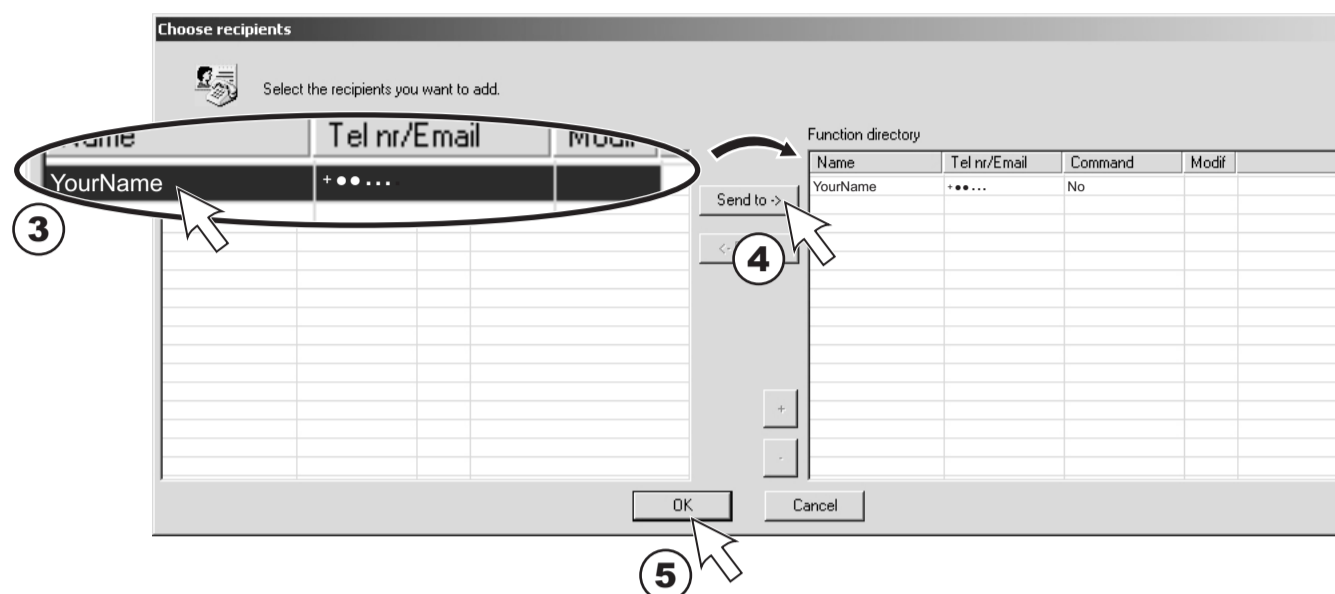
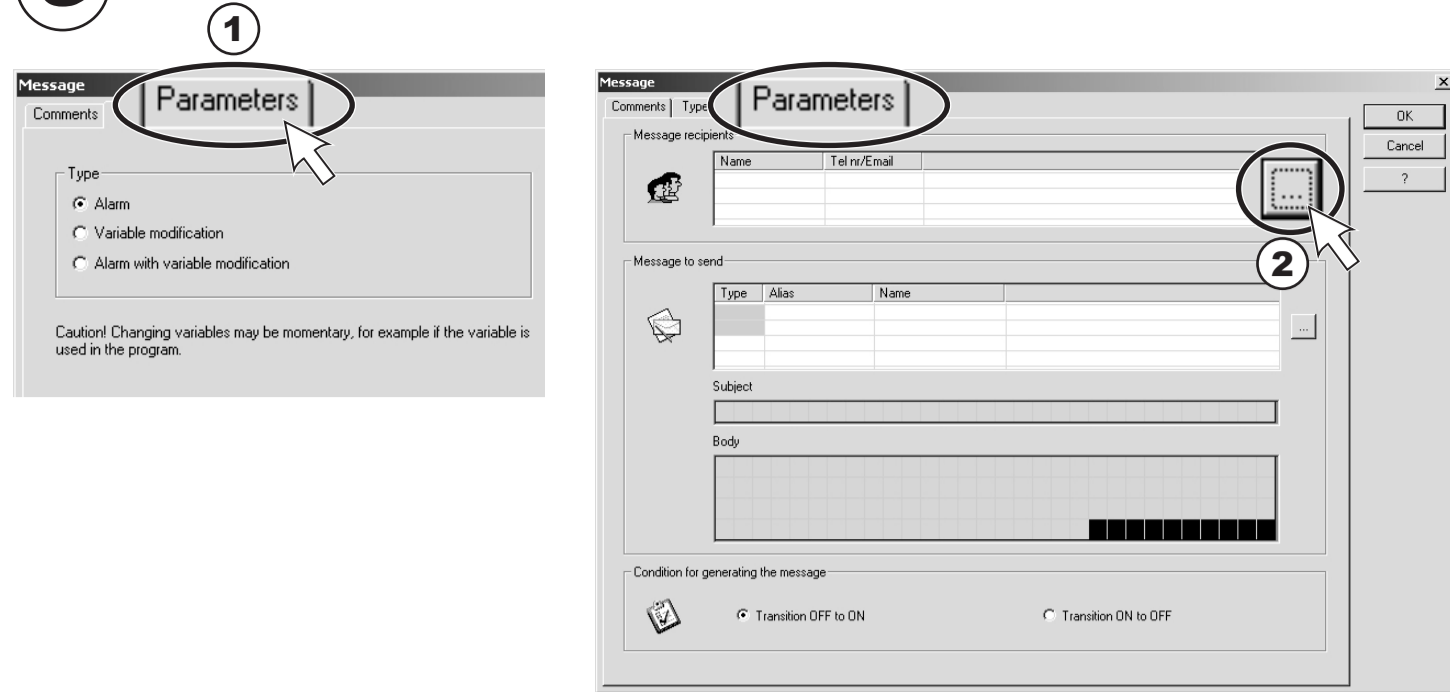

6/8

H

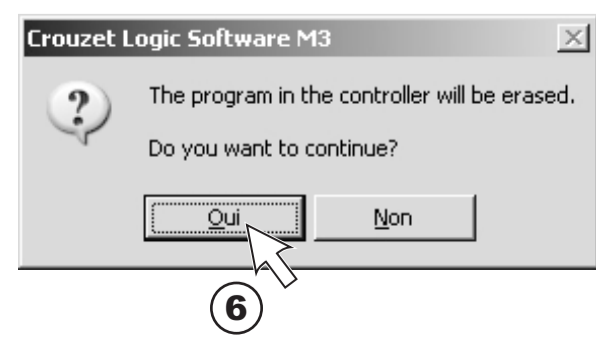
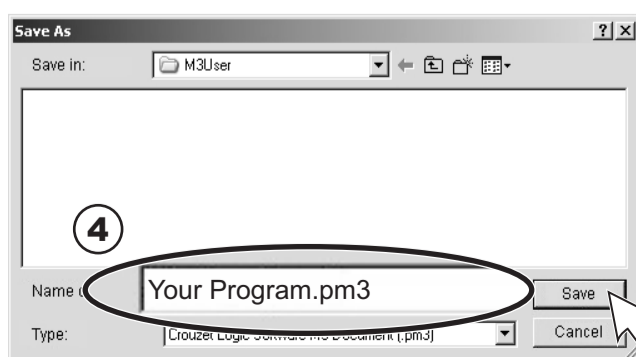
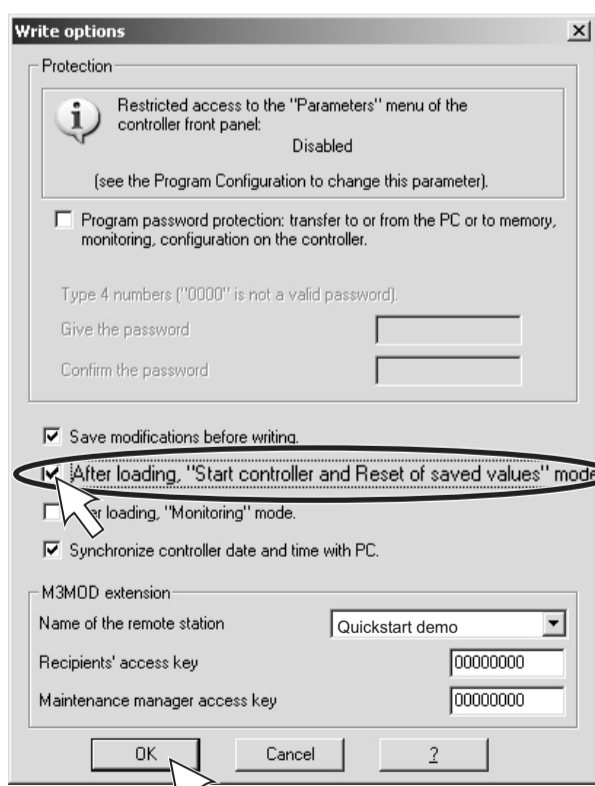
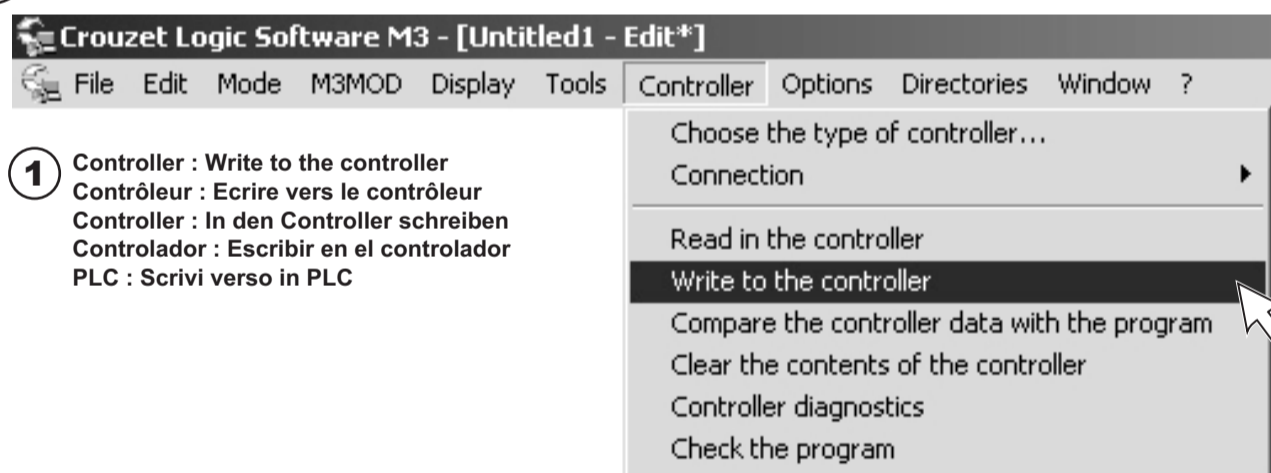

7/8

Operation / Exploitation / Betrieb / Utilización / Uso

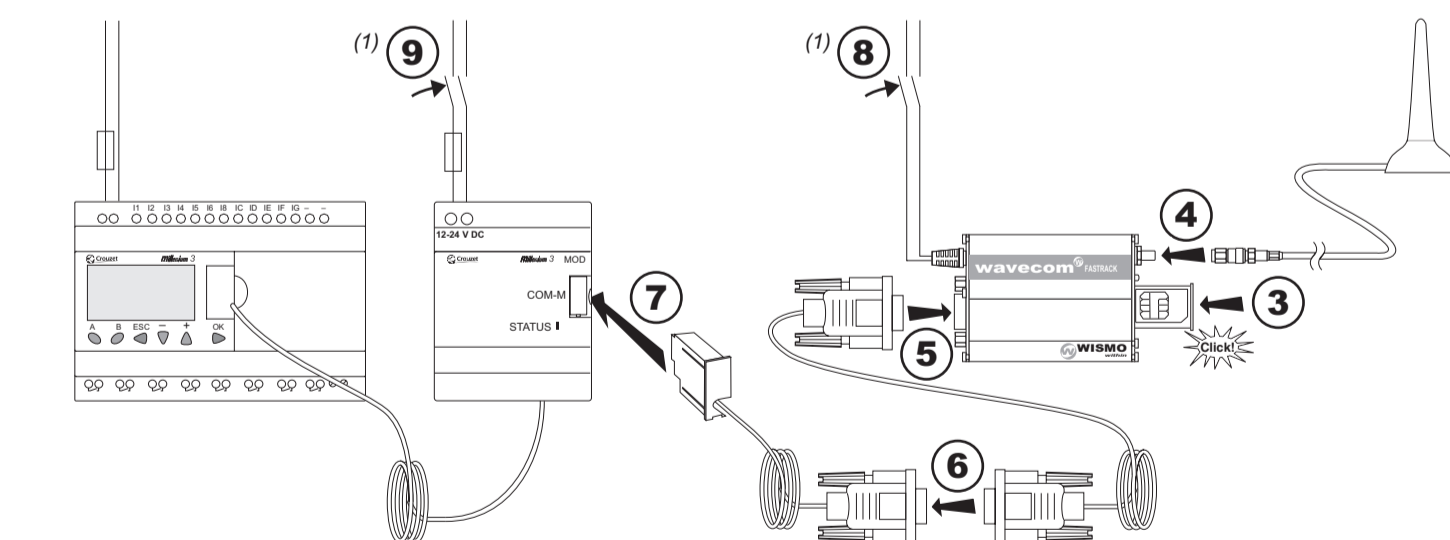
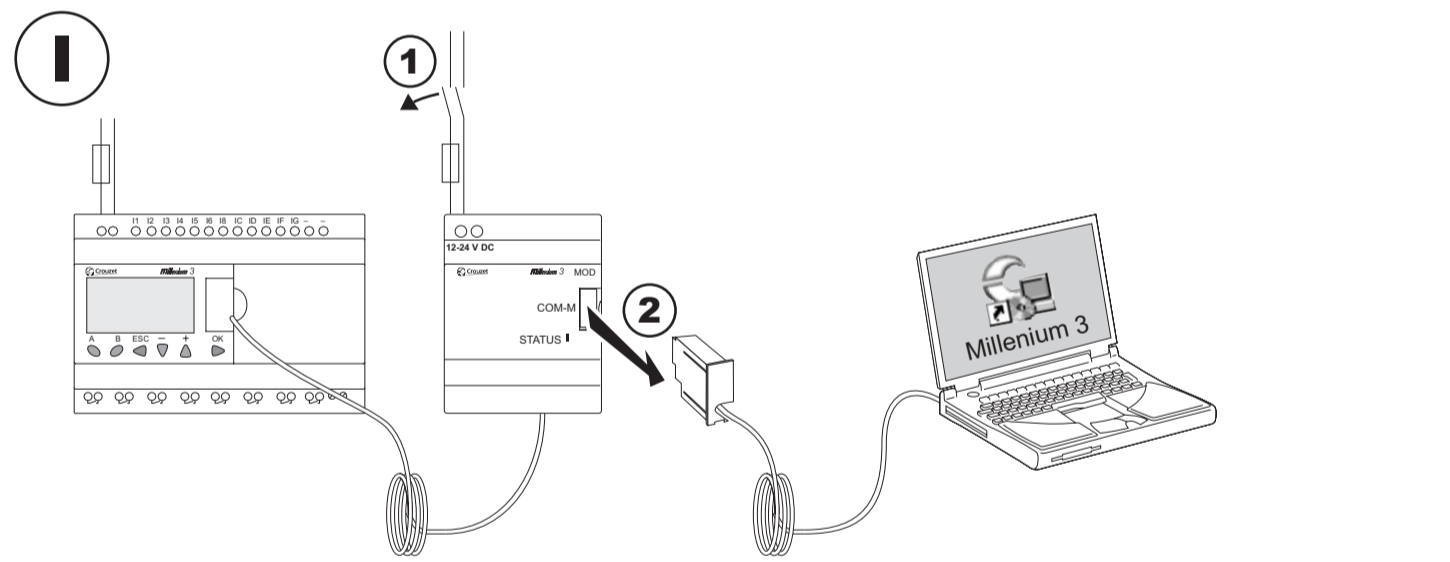

(1) Do not switch the 88 970 117 on before the 88 970 119. / Ne mettez pas sous tension le 88 970 117 avant le 88 970 119.
 Schalten Sie das 88 970 117 nicht vor dem 88 970 119. / No conecte el dispositivo 88 970 117 antes del 88 970 119.
 Non mettere sotto tensione la 88 970 117 prima della 88 970 119.

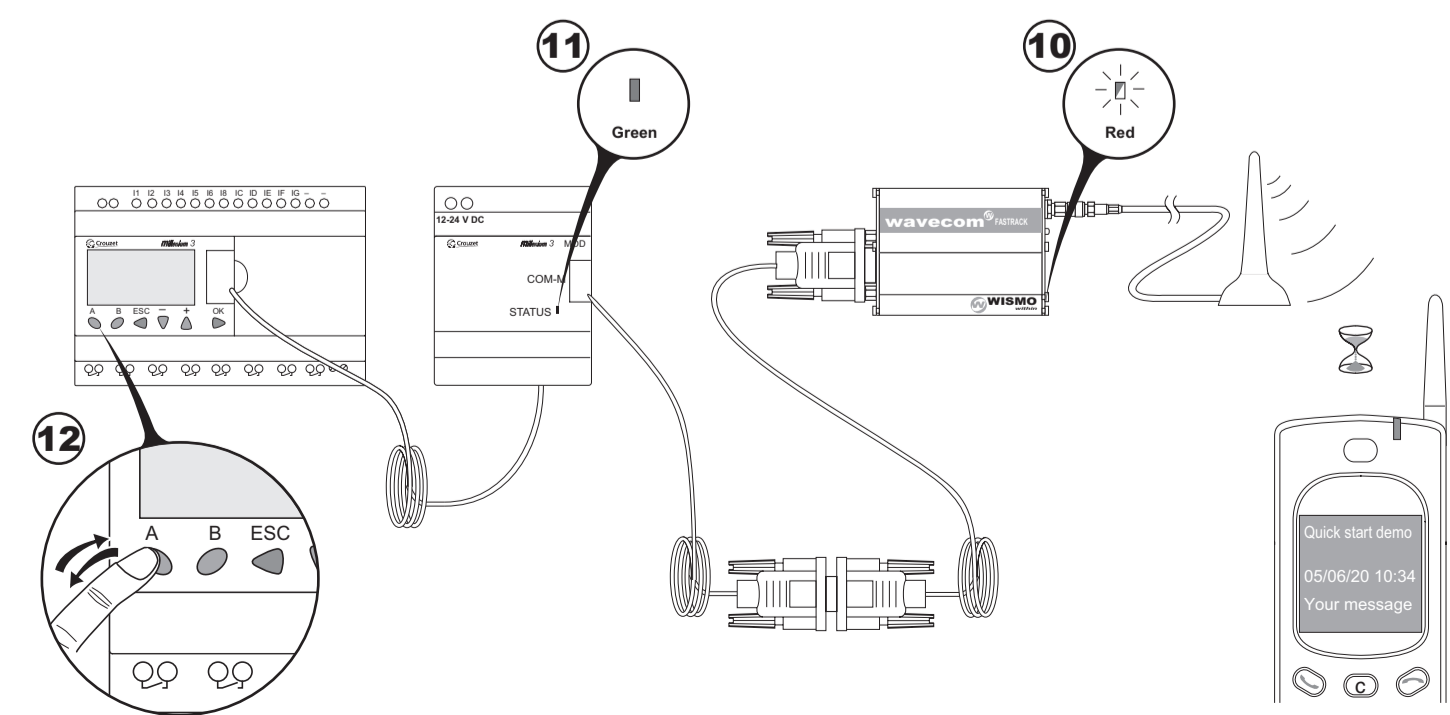

8/8