

CamCon Terminal

DC51/T



Digitronic Automationsanlagen GmbH

Steinbeisstraße 3 · D - 72636 Frickenhausen · Tel. (+49)7022/40590-0 · Fax -10
Auf der Langwies 1 · D - 65510 Hünstetten-Wallbach · Tel. (+49)6126/9453-0 · Fax -42
Internet: <http://www.digitronic.com> · E-Mail: mail@digitronic.com

For your attention

This instruction manual relates to the CamCon DC51/T from 10/2003. The company Digitronic Automationsanlagen GmbH reserves the right to make changes which present an improvement of the quality or functionality of the device without prior notice. The instruction manual was created with great care, although it may not be error-proof. We would be grateful for any communication relating to any errors you may have found.

UP-date

You can also obtain this instruction manual on the Internet at <http://www.digitronic.com> in the latest version as PDF file.

Qualified personnel

This device may only be started and operated by qualified staff. By qualified we mean personnel who are entitled to handle, to earth and to label devices, systems and power circuits in accordance with the technology safety standards.

Liability

(1) The supplier is liable for damages caused by himself or by the owner of the rights up to the sum of the sales price. He is not liable for loss of profits, forfeited savings, intermediate and successive damages.

(2) The above mentioned limits to liability do not apply to insurance of named characteristics and damages which were caused deliberately or through negligence.

Protection

The CamCon DC51/T and this instruction manual are protected by copyright. All rights are reserved. Neither the CamCon DC51/T, nor this document may be copied as a whole or partially, photocopied, reproduced, translated or transferred to electronic media of any kind or into machine readable format without prior written permission by the company Digitronic Automationsanlagen GmbH.

Note: We have examined the devices of the CamCon series for year 2000 compatibility and have not found any adverse effects on any functions.

Note: CamCon is a registered trademark of the company Firma Digitronic Automationsanlagen GmbH.

Note: The devices of the CamCon series comply with the standards for electromagnetic compatibility: EN 55011, EN 55022, EN 55024 Part 2, EN 50082 Part 2, ENV 50140, VDE 0843 Part 2, VDE 0843 Part 4, VDE 0871, VDE 0875 Part 3 ("N"), VDE 0875 Part 11, VDE 0877 Part 2, IEC 801 Part 3, IEC 801 Part 2, IEC 801 Part 4, IEC 801 Part 5.



(c) Copyright 1992 - 2004 / File: DC50T_E.DOC

Digitronic Automationsanlagen GmbH
Auf der Langwies 1
D-65510 Hünstetten - Wallbach
Tel. (+49)6126/9453-0 Fax. (+49)6126/9453-42
Internet: <http://www.digitronic.com>
E-Mail: mail@digitronic.com

Table of contents

1. Introduction 3

2. Installation 4

2.1. Dimensions 4

3. Electrical connections 5

3.1. Pin allocation of the CamCon Terminal 5

3.1.1. Pin allocation of the voltage supply 5

3.1.2. Pin allocation of the serial interface 5

3.1.2.1. Pin allocation of the serial RS232 interface 5

3.1.2.2. Pin allocation of the serial RS485 interface 6

4. Commissioning 7

5. Operation of the CamCon Terminal 7

5.1. The main menu 7

5.1.1. LCD - contrast setting 8

5.1.2. Menu "1 Start Terminal" 8

5.1.3. Menu "2 Programme selection" 9

5.1.4. Menu "3 Unit list" 9

5.1.5. Menu "4 Terminal config." 10

5.1.5.1. Sub menu "Terminal konfig." 10

5.1.5.2. The communication mode or terminal mode (Ser.Mode) 10

5.1.5.2.1. The "Cam-BUS" communication mode 10

5.1.5.2.2. The "Standard" communication mode 11

5.1.5.2.3. The "Multiuser" communication mode 11

5.1.5.2.4. The "S5 - L1" communication mode 11

5.1.5.2.5. The "3964R" communication mode 11

5.1.6. Menu "5 Terminal Language" 11

5.1.6.1. submenu "device group" 11

5.1.6.2. Submenü "Key code administration" 12

6. Technical data 12

7. Key word table 13

1. Introduction

The CamCon Terminal DC51T is a graphic programming unit for cam controllers of the CamCon family.

As a standard, the CamCon Terminal is equipped with background illumination and an RS485 interface, but it can also come with an RS232 interface upon request. The CamCon Terminal is connected to the cam controller via the serial interface and shows the transmitted data on its display screen. The operation of the cam controllers is done as described in the corresponding handbooks. This is the same for the devices of the CamCon series DC16/50/51/90/115/300 and differs only in the performance of the different unit' s hardware.

The operation of the CamCon Terminal is described in chapter "5. Operation of the CamCon Terminal" on page 7 .

2. Installation

The unit is inserted into a cutout for front plate installation (see chapter "2.1. Dimensions" on page 4). Connect the ground pins on the back of the encasement as well as the cable cover to a grounding point of the switchboard door in the shortest possible way. All cable connections must be done in a cold state! The connection cables, e.g. for the measuring system or the serial interface, must be wired with covers, and the covers have to be grounded on both ends. Analog signals must also be wired with covers, and the covers have to be grounded on one end.

2.1. Dimensions

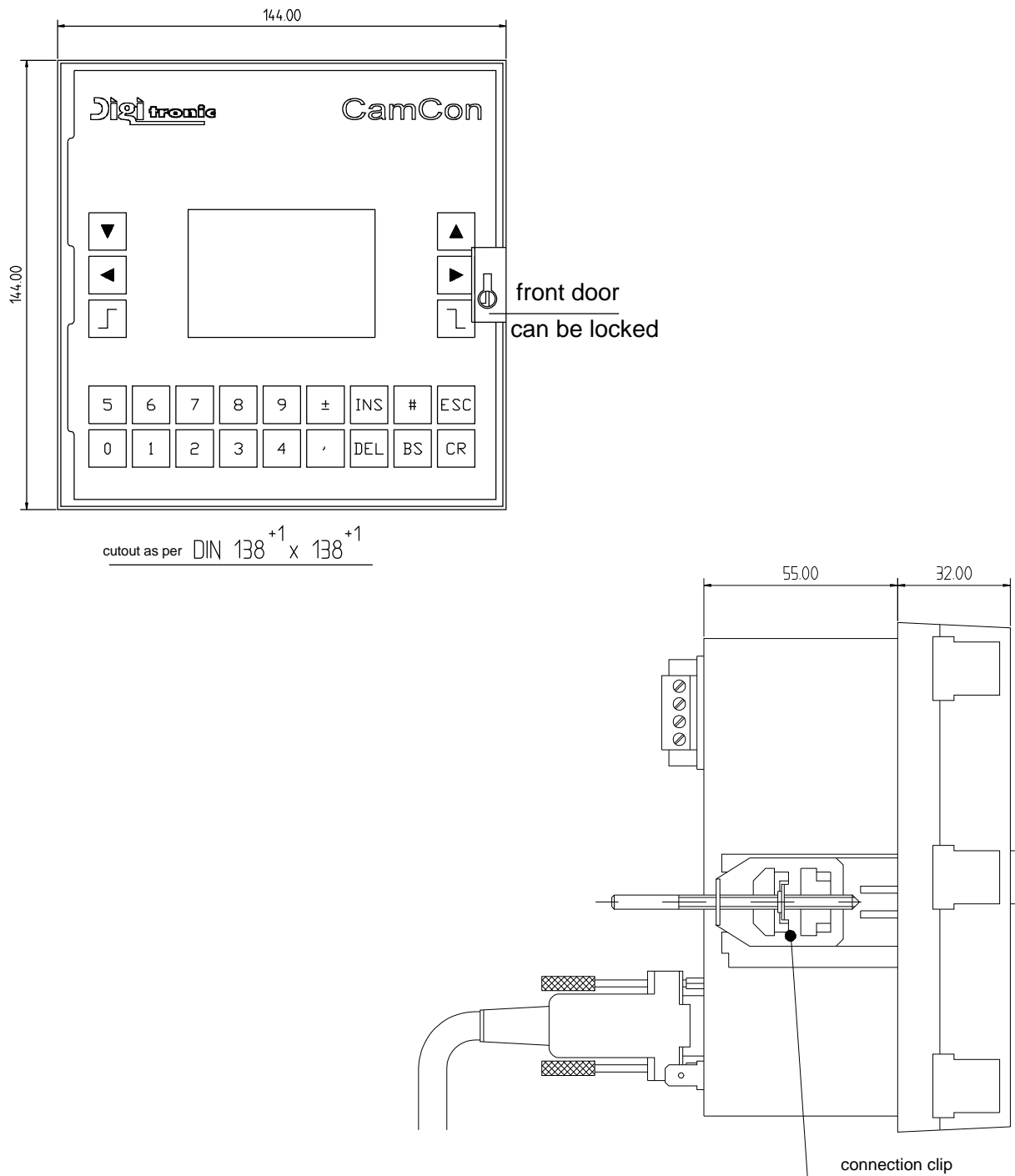

Fig.: Drawing to help with the installation of the CamCon Terminal

3. Electrical connections

3.1. Pin allocation of the CamCon Terminal

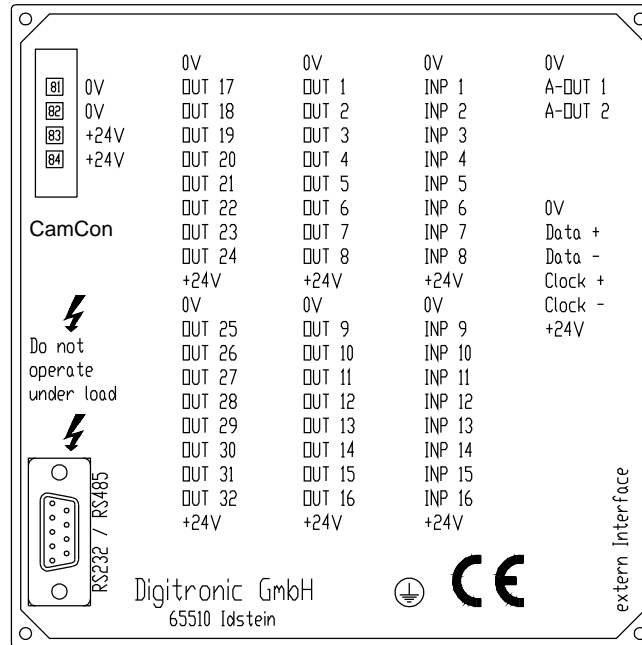

Fig.: Rearview of the CamCon Terminal with pin allocation

3.1.1. Pin allocation of the voltage supply

Pin	81:	0V voltage supply
Pin	82:	0V voltage supply
Pin	83:	+24V DC voltage supply
Pin	84:	+24V DC voltage supply

3.1.2. Pin allocation of the serial interface

You can specify the type of the serial interface (RS232 or RS485) with your order. Depending on the type of serial interface, the connections and the wiring change (DC51/T4 = RS485 / DC51/T2 = RS232).

3.1.2.1. Pin allocation of the serial RS232 interface

DSUB 9 pinboard: RS232 Interface for PC attachment (max. 15m cable length)

Pin	1,4	Do not connect !
Pin	2	TXD
Pin	3	RXD
Pin	5	GND
Pin	6-9	N.C.

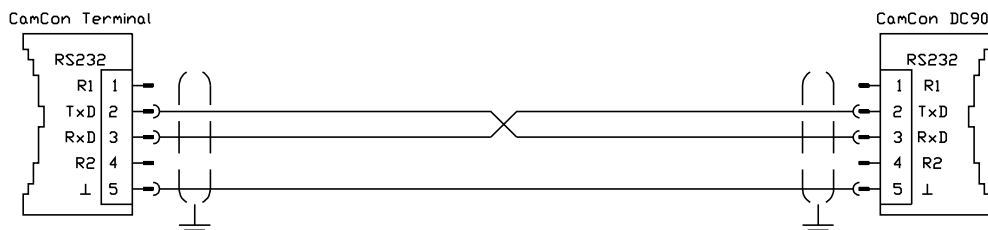

3.1.2.2. Pin allocation of the serial RS485 interface

DSUB 9 pinboard: RS485 interface links many devices (max. 1000m cable length).

Pin	1,4	Closedown resistors
Pin	2	B (-)
Pin	3	A (+)
Pin	5	GND
Pin	6-9	N.C.

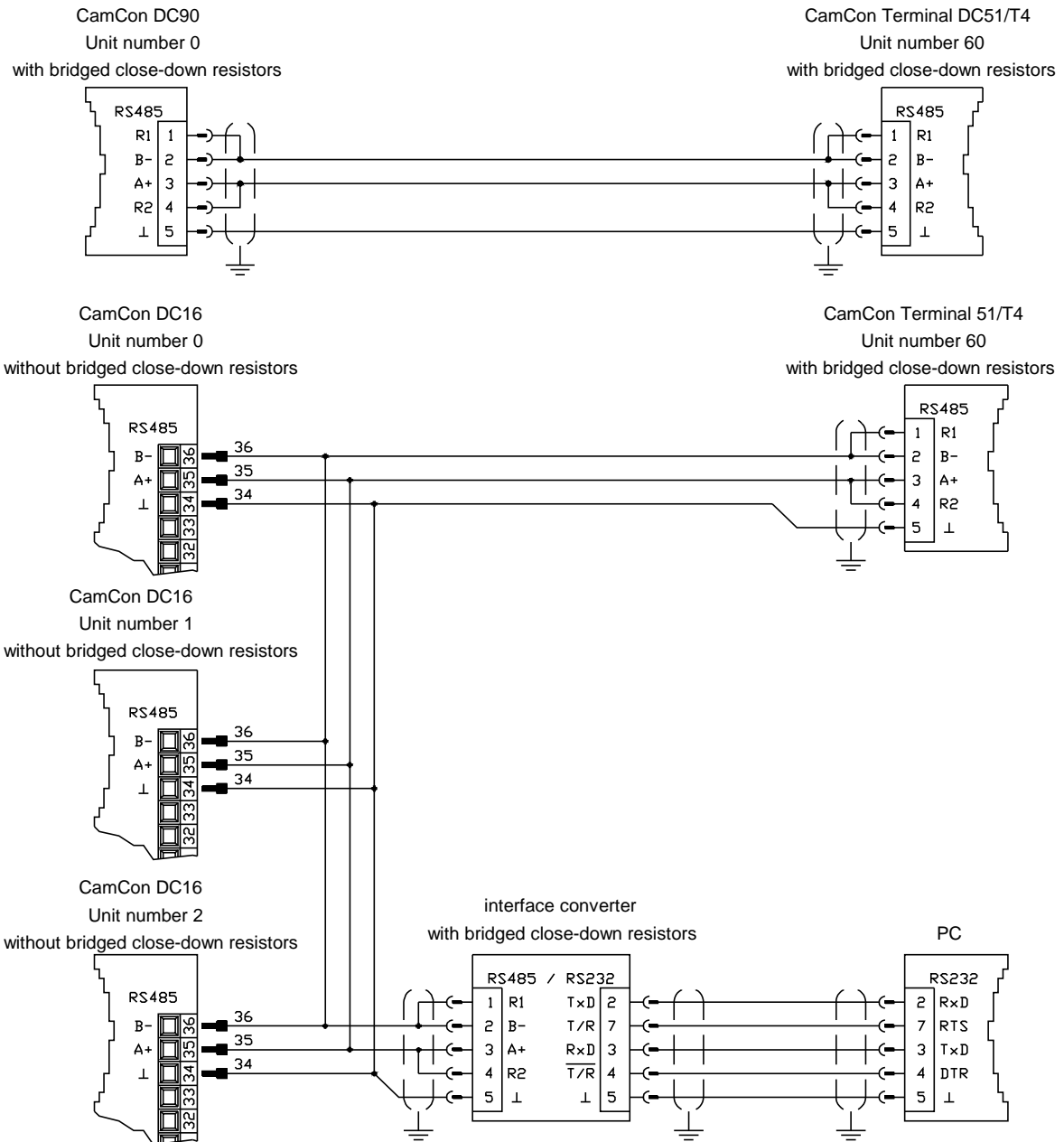

Note: The pins 1 and 2, as well as the pins 3 and 4 have to be bridged in the attachment plug of the first and last device in a networked chain at the RS485 Interface, to close the data and reception line perfectly. Corresponding closedown resistors are attached to the system at pin 1 and 4.

4. Commissioning

Please check the wiring before activating the device for the first time. See chapter "3.1. Pin allocation of the CamCon Terminal" on page 5.

After being switched on the CamCon will generate a short tone. Afterwards it will start the internal review and the running up of the system (e.g. to generate the proof total of the EEPROM and the EPROM). This process takes several seconds. After a successful installation of the system, the CamCon Terminal tries to establish contact with the cam controller that it communicated with before the last deactivation. If this cam controller is found, the CamCon Terminal displays the cam controller's main menu on its screen. "No contact with unit XX !" is displayed, if this cam controller is not found (XX stands for the unit number of the cam controller).

5. Operation of the CamCon Terminal

5.1. The main menu

After the activation of the supply voltage, the terminal tries to make contact with a CamCon cam controller. If this fails, the device displays the following message after 5 seconds:

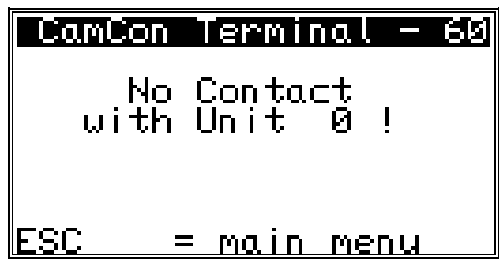

You return to the main menu by pressing the **ESC** key once. The text "CamCon Terminal", as well as the unit number, is displayed in the top line of the main menu.
Attention: The unit - or device numbers may only be allocated once on an CamCon RS485 BUS.

The main menu is the starting point of the operation. You can select the desired menu by pressing the corresponding numeric key, or by moving the black beam on the desired menu point with the keys **▼** and **▲** and confirming your selection with the **CR** key.

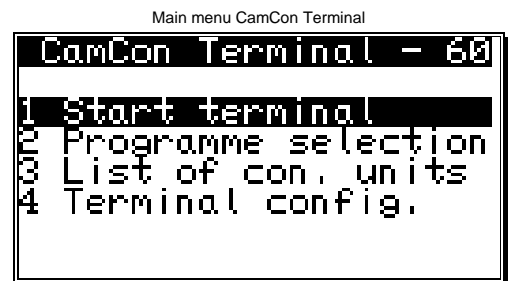

If contact is made to a CamCon cam controller after activation, its main menu is displayed. The upper righthand corner of the display shows the unit number of this cam controller. This number is e.g. 1. To break the connection from cam controller to the Terminal, leave any current submenu of the cam controller by pressing the **ESC** key.

When you are in the main menu, press the **ESC** key for about 2 seconds, and you return to the main menu of the CamCon Terminal. Here you have the possibility to select four submenus. In the submenus 2, 3 and 4, you can always return to the main menu by pressing the **ESC** key once. Menu 1 can be left only by holding the **ESC** key pressed for about 2 seconds. The following chapters describe the different menu points and their functions in details.

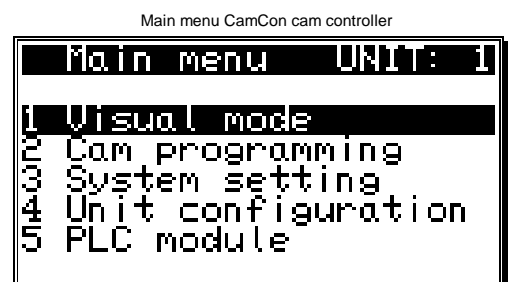

5.1.1. LCD - contrast setting



To adjust the LCD display contrast, enter the main menu of the CamCon Terminal. Press the **#** key to let the display show the Digitronic Logo. Here (and only here) you can adjust the contrast of the Liquid Crystal Display with the keys **▲** and **▼**. Holding these keys pressed in - or decreases the contrast continually. Pressing the **ESC** ends the input, and the Terminal automatically tries to establish contact with a CamCon cam controller.

5.1.2. Menu "1 Start Terminal"

You choose this menu, when you want to make contact with a CamCon cam controller. After having selected this menu, the display shows the request for the input of the unit number with which you want

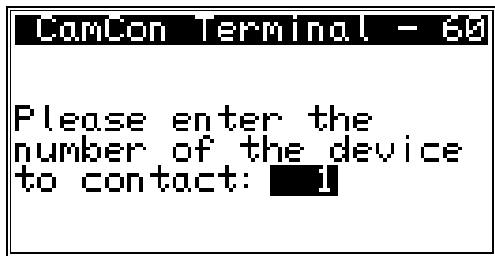

to make contact. Here you can enter a number between 0 and 63. Entering the unit number of the Terminal is not a valid input. In the picture to the left, this number is e.g. 60. By pressing the **CR** key, the input is confirmed and the Terminal tries to make contact with a device with that unit number.

Once a data connection is established the main menu of the cam controller is displayed on the screen of the Terminal. Now you can start with the programming of your cam controller, as described in the corresponding handbooks. To break the connection between Terminal and cam controller, leave any current submenu of the cam controller by pressing the **ESC** key. Back in the main menu, press and hold down the **ESC** key for about 2 seconds, and return to the main menu of the CamCon Terminal.

Note: If you use the CamCon Terminal with several CamCon cam controllers on one RS485 BUS, you have to connect the devices and allocate the different unit numbers one by one, as well as the communication mode ("**Ser.Mode**"). Any unit number may only be assigned to **one device**, and the communication mode has to be set to "**Ser.Mode**" on all devices (see chapter 5.1.5. Menu "4 Terminal config. on page 10 and in the corresponding handbooks of the CamCon cam controllers DC16,50,90 and DC115). At the RS485 BUS, the only valid settings are "**Multiuser**" and "**CAM-BUS**". If a setting to the "**Ser.Mode**" communication mode is not possible with any device, get a software upgrade for it.

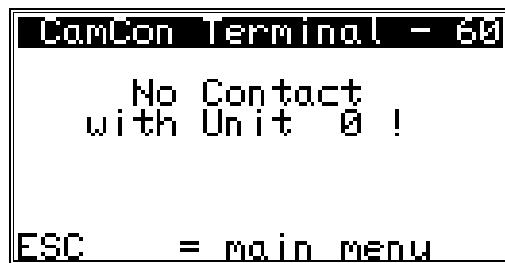

If contact is not made, the message "No contact with unit 0 !" is displayed after 5 seconds. Press the **ESC** key once to return to the main menu. One cause for a connection failure could be an invalid setting in the configuration (see above) or an error in the wiring of the serial interface (see page 6).

5.1.3. Menu "2 Programme selection"

In this menu you accomplish a program selection for several devices at the same time. The program selection functions **only**, if the communication mode ("**Ser.Mode**") is adjusted to "**Multius**" or to "**CAMBUS**". Before you can continue, enter your user key with the access to the program selection

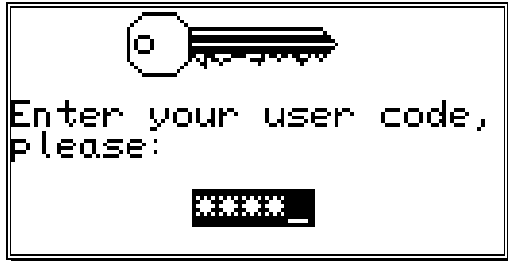

If you did not assign a user key, enter the keycode "5693" and press the key **CR**. Afterwards the menu in the screen, represented down, appears.

Programme selection												
PRG:	1	0	1	2	3							
4	5	6	7	8	9	10	11	12	13			
14	15	16	17	18	19	20	21	22	23			
24	25	26	27	28	29	30	31	32	33			
34	35	36	37	38	39	40	41	42	43			
44	45	46	47	48	49	50	51	52	53			
54	55	56	57	58	59	--	61	62	63			

Only the devices marked with "#" are selected. After the input of the program number the program selection begins. That mark of the devices is possible only in the submenu "device group" (see chapters 5.1.6.1. submenu "device group" on page 11).

Programme selection												
PRG:	1	0	1	2	3							
4#	5#	6#	7	8	9	10	11	12	13			
14	15	16	17	18	19	20	21	22	23			
24	25	26	27	28	29	30	31	32	33			
34	35	36	37	38	39	40	41	42	43			
44	45	46	47	48	49	50	51	52	53			
54	55	56	57	58	59	--	61	62	63			

The already black supported devices were successfully selected. In the example left in the device 3 the program 1 was selected. Next program 1 in device 4 is selected. After completion of the program selection a message appears. If an error message appears, then program selection was not possible and is again to be implemented. Possible sources of error are wrong device numbers or errors in the wiring of the serial interface

The program selection can be left at any time by operation of the **ESC** key.

5.1.4. Menu "3 Unit list"

Select this menu to see an outline of all units with their unit numbers of the RS485 BUS. After selecting this menu point, the following menu appears on the display:

list of con. units												
MULTI.	0	1	2	3								
4	5	6	7	8	9	10	11	12	13			
14	15	16	17	18	19	20	21	22	23			
X	25	26	27	28	29	30	31	32	33			
34	35	36	37	38	39	40	41	42	43			
44	45	46	47	48	49	50	51	52	53			
54	55	56	57	58	59	--	61	62	63			

If a device is found on the RS485 BUS, it is marked with an "X" after its unit number. The terminals own unit number is marked by "--". Left above the recognized communication mode ("Ser.mode") is indicated.

In the example, the unit numbers 0, 1, and 61 were found on the RS485 BUS whose communication mode has been set to "**Multius**".

Press the **ESC** key to return to the main menu.

5.1.5. Menu "4 Terminal config."

You select this menu, in order to configure the terminal.

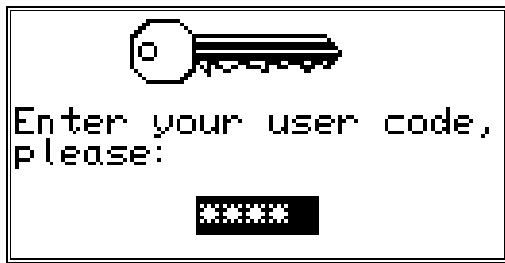

Before you can continue, enter your user key with the access to the device configuration. If you did not assign a user key, enter the keycode "5693" and press the key .

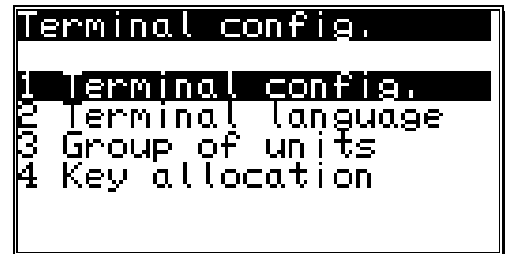

Afterwards the submenu in the screen, represented right, appears.

5.1.5.1. Sub menu "Terminal konfig."

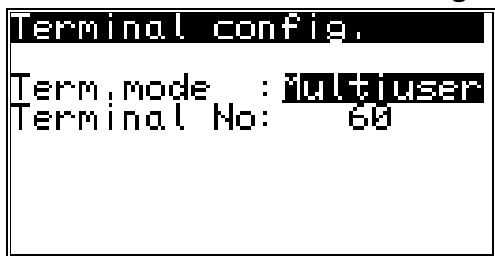

You select this menu, if you want to adjust the communication mode and the CamCon terminal unit number. The communication mode becomes here by the designation "Term mode" and the unit - and/or device number by the designation "Terminal no." shortened. For the selection of the communication mode by pressing of the keys and the desired communication mode is selected and taken over by the pressing of the key .

If the assumption took place, then now the input of the Terminals No. or device number is expected. Also this is taken over with the key and can vary between 0 to 63. The specification of the individual terminal modes takes place in the next chapter

Press the key once to return to the main menu.

5.1.5.2. The communication mode or terminal mode (Ser.Mode)

The CamCon Terminal offers five different communication modes. These are 1. = "Cam-BUS", 2. = "Standard", 3. = "Multiuser" 4. = "S5-L1" and 5. = "3964R". If a specific mode is selected, make sure that every device with which you want to communicate supports that communication mode. Please note that you have the option of selecting the type of interface you want with your offer: DC51/T4 = RS485 or DC51/T2 = RS232. All five communicationmodes work as well in the RS232 point to point communication as in the RS485 BUS communication.

5.1.5.2.1. The "Cam-BUS" communication mode

Select this setting, if wish to be able to program and display one or more CamCons from different terminals. This is e.g. the case, if you want the Camcon Terminal DC51/T4, the daughter display CD10 and the PC to communicate with one or several devices via an RS485 BUS.

Attention: With this setting, **all** CamCon devices and connected PCs with an RS485 interface have to be equipped with a software version from December1996 or later.

5.1.5.2.2. The "Standard" communication mode

The standard operation works only in connection with an RS485 interface and is a point to point communication. This means that only two devices can be connected (e.g. DC90 and DC50/51 terminal). Since this mode does not support protocol security, it may only be used for testing purposes.

5.1.5.2.3. The "Multiuser" communication mode

On the contrary to the "Cam-BUS" mode, it is **not** possible to operate several devices like e.g. the CamCon Terminal DC51/T4, the daughter display CD10 or the PC on the RS485 BUS.

5.1.5.2.4. The "S5 - L1" communication mode

This setting is necessary to program a cam controller set to the Siemens "S5 - L1" BUS. This is a point to point communication, meaning that only the CamCon Terminal and the CamCon cam controller can be connected.

5.1.5.2.5. The "3964R" communication mode

This setting is necessary to program a cam controller set to the "3964R" communication mode. This is a point to point communication, meaning that only the CamCon Terminal and the CamCon cam-switch can be connected.

5.1.6. Menu "5 Terminal Language"

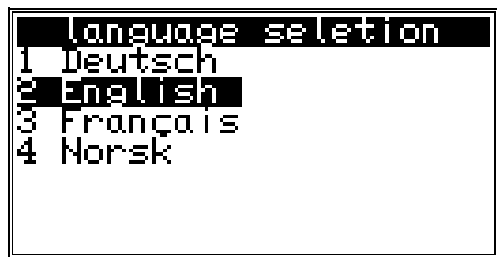

If you selected the menu point "Language" in the main menu, you enter the menu for the selection of the terminal language. Here you can select the desired language with the keys and and confirm it with the key.

Note: The language settings of the CamCon Terminal and the CamCon cam controllers operate independently, so changing the language of the CamCon Terminal does not automatically change the language of the CamCon cam controller.

5.1.6.1. submenu "device group"

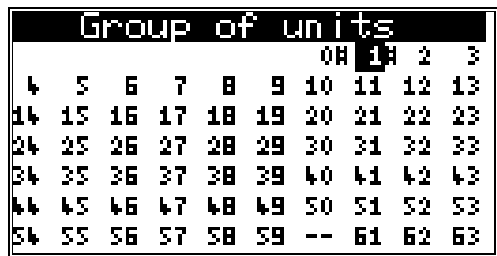

Here you can mark the devices, which in the program selection to participate (see chapter 5.1.3. Menu "2 Programme selection" on page 9). With the unit number of the terminal appears instead of the number "--". With the keys , , and can you a unit number select. With that key You select the unit numbers, which are to belong to the group. These are then marked with a "#" behind the unit number. If you marked inadvertently a wrong unit number, then you waive the marking with the key again.

With the key you come back to the terminal configuration.

5.1.6.2. Submenü "Key code administration"

With the selection key administration appears the following picture:

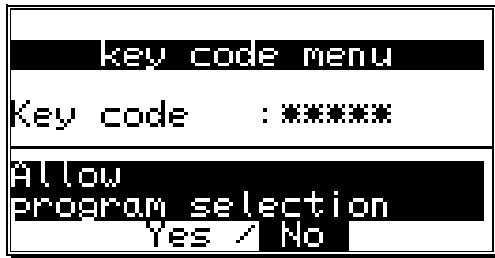

Here you can enter the user key for the terminal.

The keys permit 2 access levels.

* Access to program selection

* Access to device configuration

6. Technical data

Display	LCD Graphic display 128 x 64 pixels with background illumination.
Interface	RS485 up to max. 1000m. or RS232 up to max. 15m.
Supply voltage.....	24V DC \pm 20 %
Current absorbtion	about 300mA.
Connections for:	
Interface	via D-SUB 9
Voltage supply.....	via plug-block pins
Dimensions	see chapter "2.1. Dimensions" on page 4.
Operating temperature.....	0°C ... + 55° C
Switchboard normencasement (DIN 43700).....	144 x 144 x 55mm (WxHxD)
Weight.....	about 700g

7. Key word table

Cable covers	4
CE	2
Commisioning	7
Communication mode.....	10
communication mode.....	10
communication mode, 3964R.....	11
communication mode, Cam-BUS	10
communication mode, Multiuser	11
communication mode, S5 - L1	11
communication mode, Standard	11
device group.....	9; 11
device number	10; 11
Dimensions	4
Electrical connections	5
Grounding pins.....	4
Installation	4
Installation procedures.....	4
Key code administration.....	12
LCD - contrast setting	8
Main menu	7
Menu 1, Start Terminal	8
Menu 2, Programme selection.....	9
Menu 3, Unit list	9
Menu 4, Terminal config.	10
Menu 5, Terminal Language.....	11
millenium.....	2
Operation of the CamCon Terminal.....	7
PDF - File.....	2
Pin allocation.....	5
Pin allocation of the voltage supply.....	5
programm selection	11
Serial interface	5
Serial RS232 interface	5
Serial RS485 interface	6
Table of contents	3
Technical data.....	12
Terminal config.	10
unit number	10
UP - Date	2
user key.....	9
Y2K	2
User code.....	9