











### 5. OUTPUT

Output voltage	nom.	24V	
Adjustment range	min.	23-28V	guaranteed
	max.	30V	at clockwise end position of potentiometer
Factory setting		24.1V	±0.2%, at full load, cold unit
Line regulation	max.	25mV	Input voltage variations between 36 to 60Vdc
Load regulation	max.	100mV	static value, 0A → 5A
Ripple and noise voltage	max.	50mVpp	20Hz to 20MHz, 50Ohm
Output capacitance	typ.	2 200µF	
Output current	nom.	6A	at 24V, ambient < 45°C, see Fig. 5-1
	nom.	5A	at 24V, ambient < 60°C, see Fig. 5-1
	nom.	5.2A	at 28V, ambient < 45°C, see Fig. 5-1
	nom.	4.3A	at 28V, ambient < 60°C, see Fig. 5-1
Output power	nom.	144W	for ambient temperatures < 45°C
	nom.	120W	for ambient temperatures < 60°C
Short-circuit current	min.	7A	continuous current, short circuit impedance 200mOhm
	max.	10A	continuous current, short circuit impedance 200mOhm

Fig. 5-1 Output voltage vs. output current, at 48Vdc input voltage, typ.

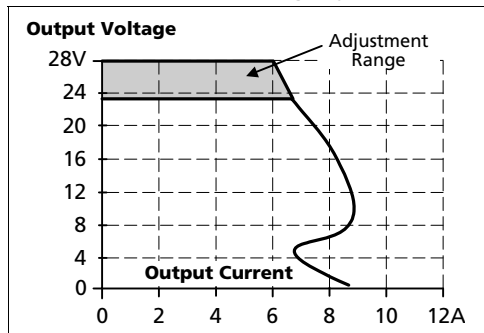
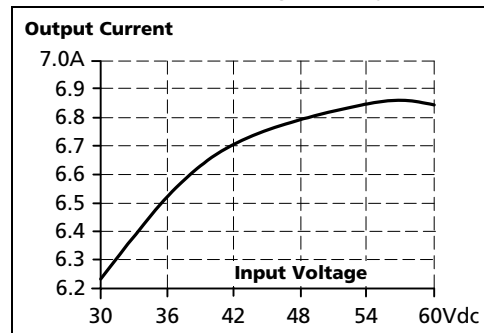

Fig. 5-2 Current limitation vs. input voltage, (23V constant voltage load), typ.



#### Peak current capability (up to several milliseconds)

The DC/DC converter can deliver a peak current, which is higher than the specified short term current. This helps to start current demanding loads or to safely operate subsequent circuit breakers.

The extra current is supplied by the output capacitors inside the DC/DC converter. During this event, the capacitors will be discharged and causes a voltage dip on the output. Detailed curves can be found in chapter 22.1.

Peak current voltage dips	typ.	from 24V to 17.1V	at 10A for 50ms, resistive load
	typ.	from 24V to 15V	at 20A for 2ms, resistive load
	typ.	from 24V to 11V	at 20A for 5ms, resistive load









## 10. TERMINALS AND WIRING

	Input	Output
Type	screw terminals	screw terminals
Solid wire	0.5-6mm <sup>2</sup>	0.5-6mm <sup>2</sup>
Stranded wire	0.5-4mm <sup>2</sup>	0.5-4mm <sup>2</sup>
American Wire Gauge	20-10 AWG	20-10 AWG
Wire stripping length	7mm / 0.275inch	7mm / 0.275inch
Screwdriver	3.5mm slotted or Pozidrive No 2	3.5mm slotted or Pozidrive No 2
Recommended tightening torque	1Nm, 9lb.in	1Nm, 9lb.in

### Instructions:

- Use appropriate copper cables that are designed for an operating temperature of:  
60°C for ambient up to 45°C and  
75°C for ambient up to 60°C minimum.
- Follow national installation codes and installation regulations!
- Ensure that all strands of a stranded wire enter the terminal connection!
- Up to two stranded wires with the same cross section are permitted in one connection point.
- Do not load the terminals with more than 25A! See section 22.9
- Screws of unused terminal compartments should be securely tightened.
- Ferrules are allowed, but not required

## 11. RELIABILITY

	Input 48Vdc	
Lifetime expectancy *)	169 000h	at 24V, 2.5A and 40°C
	64 000h	at 24V, 5A and 40°C
	39 000h	at 24V, 6A and 40°C
	181 000h	at 24V, 5A and 25°C
MTBF **) SN 29500, IEC 61709	951 000h	at 24V, 5A and 40°C
	1 560 000h	at 24V, 5A and 25°C
MTBF **) MIL HDBK 217F	559 000h	at 24V, 5A and 40°C; Ground Benign GB40
	749 000h	at 24V, 5A and 25°C; Ground Benign GB25

\*) The **Lifetime expectancy** shown in the table indicates the minimum operating hours (service life) and is determined by the lifetime expectancy of the built-in electrolytic capacitors. Lifetime expectancy is specified in operational hours and is calculated according to the capacitor's manufacturer specification. The prediction model allows only a calculation of up to 15 years from date of shipment.

\*\*) **MTBF** stands for **Mean Time Between Failure**, which is calculated according to statistical device failures, and indicates reliability of a device. It is the statistical representation of the likelihood of a unit to fail and does not necessarily represent the life of a product.















## 22. APPLICATION NOTES

### 22.1. PEAK CURRENT CAPABILITY

Solenoids, contactors and pneumatic modules often have a steady state coil and a pick-up coil. The inrush current demand of the pick-up coil is several times higher than the steady-state current and usually exceeds the nominal output current (including the PowerBoost) The same situation applies, when starting a capacitive load.

Branch circuits are often protected with circuit breakers or fuses. In case of a short or an overload in the branch circuit, the fuse needs a certain amount of over-current to trip or to blow. The peak current capability ensures the safe operation of subsequent circuit breakers.

Assuming the input voltage is turned on before such an event, the built-in large sized output capacitors inside the DC/DC converter can deliver extra current. Discharging this capacitor causes a voltage dip on the output. The following two examples show typical voltage dips:

Fig. 22-1 **Peak loading with 2x the nominal current for 50ms, typ.**

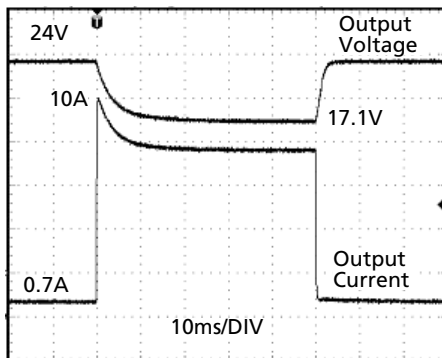

Peak load 10A (resistive load) for 50ms  
Output voltage dips from 24V to 17.1V.

Fig. 22-2 **Peak loading with 4x the nominal current for 5ms, typ.**

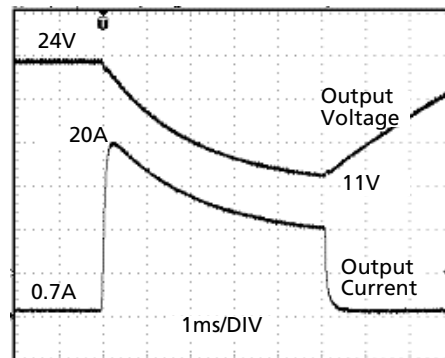

Peak load 20A (resistive load) for 5ms  
Output voltage dips from 24V to 11V.

### 22.2. BACK-FEEDING LOADS

Loads such as decelerating motors and inductors can feed voltage back to the DC/DC converter. This feature is also called return voltage immunity or resistance against Back- E.M.F. (Elemagnetic Force).

This DC/DC converter is resistant and does not show malfunctioning when a load feeds back voltage to the DC/DC converter. It does not matter, whether the DC/DC converter is on or off.

The maximum allowed feed-back-voltage is 30Vdc. The absorbing energy can be calculated according to the built-in large sized output capacitance which is specified in chapter 5.

### 22.3. INDUCTIVE AND CAPACITIVE LOADS

The unit is designed to supply any kind of loads, including unlimited capacitive and inductive loads.

### 22.4. CHARGING OF BATTERIES

The DC/DC converter can be used to charge lead-acid or maintenance free batteries. (Two 12V batteries in series)

**Instructions for charging batteries:**

- a) Ensure that the ambient temperature of the DC/DC converter is below 45°C
- b) Do not use DC/DC converters in mounting orientations other than the standard mounting orientation (input terminals on the bottom and output terminals on top of the unit).
- c) Set output voltage (measured at no load and at the battery end of the cable) very precisely to the end-of-charge voltage.

End-of-charge voltage	27.8V	27.5V	27.15V	26.8V
Battery temperature	10°C	20°C	30°C	40°C

- d) Use a 6A or 10A circuit breaker (or blocking diode) between the DC/DC converter and the battery.
- e) Ensure that the output current of the DC/DC converter is below the allowed charging current of the battery.
- f) Use only matched batteries when putting 12V types in series.
- g) The return current to the DC/DC converter (battery discharge current) is typ. 26.4mA when the DC/DC converter is switched off (except in case a blocking diode is utilized).

### 22.5. EXTERNAL INPUT PROTECTION

The unit is tested and approved for branch circuits up to 50A. An external protection is only required, if the supplying branch has an ampacity greater than this. Check also local codes and local requirements. In some countries local regulations might apply.

If an external fuse is necessary or utilized, minimum requirements need to be considered to avoid nuisance tripping of the circuit breaker. A minimum value of 6A B- or 6A C-Characteristic breaker should be used.

### 22.6. REQUIREMENTS FOR THE SUPPLYING SOURCE

In certain circumstances, the input filter of the DC/DC converter can show a resonant effect which is caused by the supplying network. Especially when additional external input filters are utilized, a superimposed AC voltage can be generated on the input terminals of the DC/DC converter which might cause a malfunction of the unit. Therefore, additional input filters are not recommended. To avoid the resonant effects, the minimal resistance of the supplying network which depends on the inductance of the input network, shall be above the boundary curve in Fig. 22-3.

Fig. 22-3 External input filter requirements to avoid filter instabilities

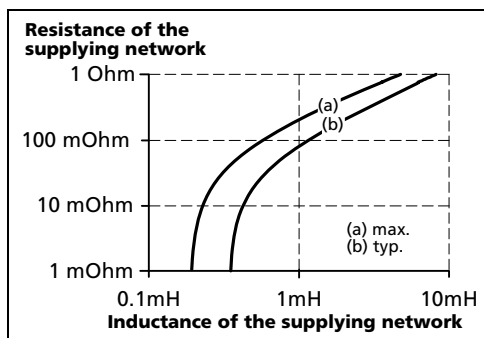

### 22.7. PARALLEL USE TO INCREASE OUTPUT POWER

The DC/DC-converter can be paralleled to increase the output power. There are no feature included which balances the load current between the DC/DC converters. Therefore some restrictions and limitations apply. The DC/DC converter with the higher adjusted output voltage draws current until it goes into current limitation. This means no harm or switch-off to this DC/DC converter as long as the ambient temperature stays below 45°C. The CD5.242 can also be paralleled with power supplies from the DIMENSION CT, QS or QT-series. For other power supplies consult PULS. Set the "single use / parallel use" jumper to "parallel use" if such an option is available.

The output voltages of all DC/DC converters shall be adjusted to the same value ( $\pm 100\text{mV}$ ) at full load. A fuse or diode on the output of each unit is only required if more than three units are connected in parallel. This avoid that more than 2 times of the nominal output current can flow backwards into the DC/DC converter in case the output stage of the DC/DC converter has a defect. If a fuse (or circuit breaker) is used, choose one with approximately 150% of the rated output current of one DC/DC converter. Keep an installation clearance of 15mm (left / right) between two DC/DC converters and avoid installing the DC/DC converters on top of each other. Do not use DC/DC converters in parallel in mounting orientations other than the standard mounting orientation (input terminals on the bottom and output terminals on top of the unit).

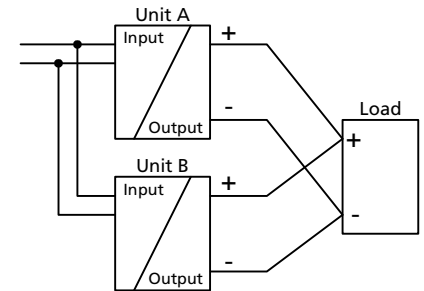

### 22.8. PARALLEL USE FOR REDUNDANCY

The DC/DC converters can be paralleled for 1+1 redundancy to gain higher system availability. Redundant systems require a certain amount of extra power to support the load in case one DC/DC converter fails. The simplest way is to put two DC/DC converters in parallel. This is called a 1+1 redundancy. In case one DC/DC converter fails, the other one is automatically able to support the load current without any interruption. Redundant systems for a higher power demand are usually built in an N+1 method. E.g. five DC/DC converters, each rated for 5A are paralleled to build a 20A redundant system.

Furthermore, 1+1 redundant systems can be built by using a DC/DC converter powered from a battery and a power supply with AC input.

**Please note:** This simple way to build a redundant system does not cover failures such as an internal short circuit in the secondary side of the DC/DC converter. In such a case, the defect unit becomes a load for the other DC/DC converters and the output voltage can not be maintained any more. This can only be avoided by utilizing decoupling diodes which are included in the decoupling module YRM2.DIODE.

Recommendations for building redundant power systems:

- Use separate input fuses for each DC/DC converter.
- Monitor the individual DC/DC converter units. A DC-ok lamp and a DC-ok contact is included in the redundancy module YRM2.DIODE. This feature reports a faulty unit.
- 1+1 Redundancy is allowed up to an ambient temperature of 60°C  
N+1 Redundancy is allowed up to an ambient temperature of 45°C
- It is desirable to set the output voltages of all units to the same value ( $\pm 100\text{mV}$ ) or leave it at the factory setting.

## 22.9. DAISY CHAINING OF OUTPUTS

Daisy chaining (jumping from one DC/DC converter output to the next) is allowed as long as the average output current through one terminal pin does not exceed 25A. If the current is higher, use a separate distribution terminal block.

Fig. 22-4 Daisy chaining of outputs

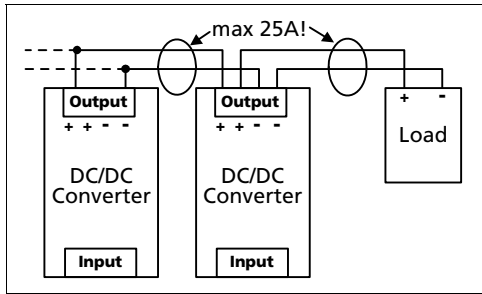
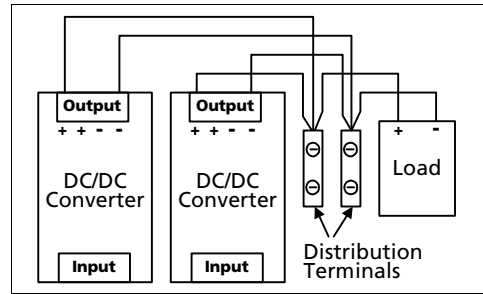
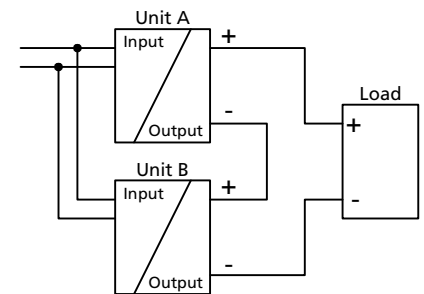

Fig. 22-5 Using distribution terminals



## 22.10. SERIES OPERATION

DC/DC converters of the exact same type can be connected in series for higher output voltages. It is possible to connect as many units in series as needed, providing the sum of the output voltage does not exceed 150Vdc. Voltages with a potential above 60Vdc are not SELV any more and can be dangerous. Such voltages must be installed with a protection against touching. Earthing of the output is required when the sum of the output voltage is above 60Vdc. Avoid return voltage (e.g. from a decelerating motor or battery) which is applied to the output terminals. Keep an installation clearance of 15mm (left / right) between two DC/DC converters and avoid installing the DC/DC converters on top of each other. Do not use DC/DC converters in series in mounting orientations other than the standard mounting orientation (input terminals on the bottom and output terminals on top of the unit).



## 22.11. USE IN A TIGHTLY SEALED ENCLOSURE

When the DC/DC converter is installed in a tightly sealed enclosure, the temperature inside the enclosure will be higher than outside. In such situations, the inside temperature defines the ambient temperature for the DC/DC converter.

The following measurement results can be used as a reference to estimate the temperature rise inside the enclosure.

The DC/DC converter is placed in the middle of the box, no other heat producing items are inside the box

Enclosure:	Rittal Typ IP66 Box PK 9516 100, plastic, 110x180x165mm
Load:	24V, 4A; (=80%) load is placed outside the box
Input:	48Vdc
Temperature inside enclosure:	42.8°C (in the middle of the right side of the DC/DC converter with a distance of 2cm)
Temperature outside enclosure:	24.0°C
Temperature rise:	18.8K

## 22.12. MOUNTING ORIENTATIONS

Mounting orientations other than input terminals on the bottom and output on the top require a reduction in continuous output power or a limitation in the max. allowed ambient temperature. The amount of reduction influences the lifetime expectancy of the DC/DC converter. Therefore, two different derating curves for continuous operation can be found below:

**Curve A1** Recommended output current.

**Curve A2** Max allowed output current (results in approximately half the lifetime expectancy of A1).

Fig. 22-6  
**Mounting Orientation A**  
(Standard orientation)

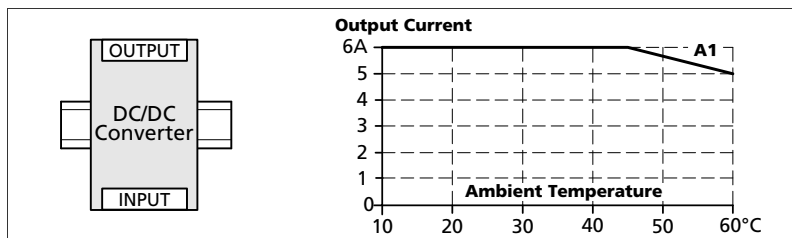

Fig. 22-7  
**Mounting Orientation B**  
(Upside down)

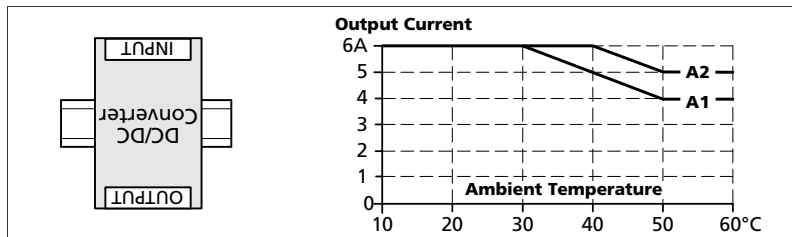

Fig. 22-8  
**Mounting Orientation C**  
(Table-top mounting)

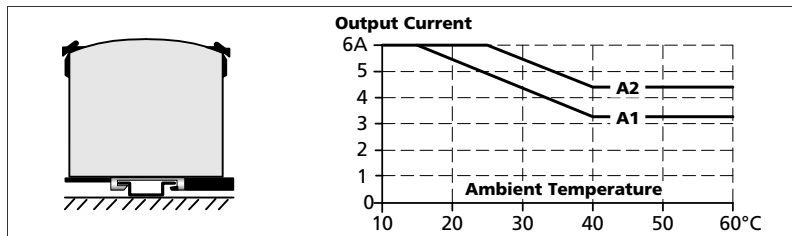

Fig. 22-9  
**Mounting Orientation D**  
(Horizontal cw)

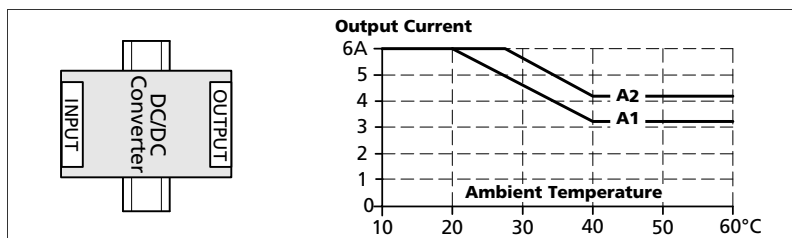

Fig. 22-10  
**Mounting Orientation E**  
(Horizontal ccw)

